

Digital Video Recorder and Product Family Instruction Manual



Designed and Manufactured in the UK 

This Instruction Manual is constantly updated. To download the latest version please go to www.tspace.co.uk

X200 Operating Software V2.0.1
PCLink Suite 7.5
 PCLink200 V1.8.2
 PCPlayer V1.8.2
 RemoteLink V1.8.2
 X-Communicate V1.8.2
 Kstation V1.0.0.4
 SafetyLink V1.0
 ImageLink V1.0
LANLink V4.0

Contents

SAFETY	3
ENVIRONMENTAL.....	4
Temperature	4
Shock and Vibration	5
EMC.....	5
Conformity	5
Recycling.....	5
SYSTEM OVERVIEW.....	11
X200 RECORDING TIME CALCULATION.....	13
COMPATIBILITY WITH X100 HARD DISK CARTRIDGES	15
CARTRIDGE COMPATIBILITY AND LABELING	16
X200 DIGITAL RECORDER.....	17
Installation	18
Connector Specifications and Diagrams	23
Service and Fail LED.....	29
Programming.....	31
Help Screens	31
Software Updates.....	32
Save User Settings.....	32
Language Selection.....	33
PAL/NTSC Switching	34
File System.....	35
Transferring Images to Video Tape.....	36
Video Compression	37
Audio	38
PC Access Precautions	39
PC Access Network Ports	39
Watermark	40
Sequencing.....	40
Watermark / Sequencing report	40
GPS	41
The Menu System V1.9.0.....	50
<i>Help Screens</i>	<i>50</i>
<i>Menu Navigation.....</i>	<i>51</i>
<i>Main Menu</i>	<i>53</i>
<i>Other Menu.....</i>	<i>54</i>
<i>Files Menu</i>	<i>55</i>
<i>Password Menu.....</i>	<i>56</i>
<i>Time and Date Menu</i>	<i>58</i>
<i>Camera Options Menu.....</i>	<i>59</i>
<i>File System Menu</i>	<i>61</i>
<i>File System Check.....</i>	<i>62</i>
<i>LAN Menu.....</i>	<i>63</i>
<i>GPS Menu</i>	<i>65</i>
<i>Statistics Menu</i>	<i>66</i>

Advanced Menu.....	67
Recording Settings Menu	69
Remote Settings Menu	70
SMS Messages Menu.....	71
SMS Status Menu.....	72
G Sensor (Accelerometer).....	73
G Sensor Setup (Accelerometer)	74
Reset System Menu	75
Normal Recording Menu.....	76
Timer Recording Menu	78
Timer Recording Times Menu	79
Shot Recording Menu	81
Audio Recording Menu	82
Motion Detection Menu.....	83
Camera Setup Menu.....	85
Alarm Recording Menu	86
Alarm Inputs Menu.....	87
Embed Alarm State Menu	89
Alarm Output / LEDs Menu.....	90
Alarm Output When Menu	91
Video Switcher 1 Menu.....	92
Video Switcher 2 Menu (X200-16 Only)	93
HARD DISK CARTRIDGE.....	94
X201 REVIEWER	95
Function.....	96
Controls	97
Audio	101
USB INTERFACE KIT	102
Transferring Files to PC	102
PCLINK SUITE	104
PCLink200 Quick Reference	105
REMOTE OPERATION (REVIEW, CONFIGURE AND DOWNLOAD)	106
LAN.....	107
WLAN	109
Recommended Modems	118
RS232 External Control.....	119
TRANSPORT FOR LONDON IBUS DIAGNOSTIC INTERFACE	126
XP200 ACCELEROMETER	128
Specification	128
Operation	128
Calibration.....	129
SPECIFICATIONS.....	130
TROUBLESHOOTING	133

SAFETY

Meets the requirements of BS EN60950 (Safety Requirements of Information Technology Equipment).

Designed to be powered from an external power source which complies with the Low Voltage Directive (73/23/EEC).

Designed for indoor use in the temperature range 5° to 40°C, 20% to 80% RH (non-condensing).

WARNING: Do not wet the product when cleaning.

WARNING: This product contains a lithium battery. Do not recharge, open, heat or dispose of in fire. Dispose of according to local regulations.

WARNING: It is important to allow enough ventilation in any surrounding enclosure so that the operating temperature range is not exceeded. Any enclosure should incorporate a fan to assist in thermal dissipation.

WARNING

The use of Hard Disk Cartridges other than those supplied by Timespace Technology will invalidate the warranty of the X200 recorder, and will constitute a breach of the X200 operating software copyright.

The purchase of USB Kit T503/505-USB includes the necessary licence for use of PCLink Suite software on one PC, including free of charge updates. Timespace Technology does not authorise the unlicensed usage of PCLink Suite software.

ENVIRONMENTAL

Temperature

The X200 may be operated in ambient temperatures from 5°C to 40°C. This specification applies in still air, with the X200 mounted horizontally and ambient temperature measured 15cms above the centre of X200.

If the X200 is to be mounted in an enclosure it is important that the internal temperature inside the enclosure does not exceed the specification above and any new enclosure design should be tested. A simple but effective test is to place a thermocouple inside the enclosure and one outside and measure the operating temperature difference. This difference must be deducted from the X200 40°C maximum.

Example

Temperature outside enclosure	25°C	
Temperature inside enclosure	<u>35°C</u>	
Difference	10°C	
Maximum inside enclosure	40°C	(X200 max)
Maximum outside enclosure	30°C	(40°C-10°C)

In the above example the 40°C max spec has been de-rated to 30°C due to the effect of the enclosure.

Forced Ventilation Within Enclosures

It is advisable to include a fan integral to any enclosure design. The goal of the fan is to remove air heated by the X200 and replace it by air at the outside temperature. The temperature difference shown in the above example of 10°C can be reduced to a few degrees using a small fan. Two small fans are typically better than one due to failsafe. Fans do need checking periodically and can draw in large amounts of dirt and dust, this should be removed periodically. To reduce dirt ingress a fan may typically be run slower than rated by reducing the voltage from that specified. This can typically be done with a single resistor in series with the fan. Alternatively air filters may be used but these impede airflow and require careful system design. The X200 does not incorporate a fan but instead uses an internal switch-mode power supply to reduce power consumption (and therefore heat).

Fans offer two immediate benefits:

- 1 Changing the air inside the case makes the air temperature inside the case within a few degrees to that outside.
- 2 If the airflow is channelled around the top surface of the X200 so that air is drawn particularly over the two sides and the top, further thermal improvement is gained and an X200 specification of 5°C to 45°C may be used. (The difference between the surface X200 case temperature and ambient temperature is typically 5°C and this is the extra maximum benefit).

Low Temperatures

Insulating the X200 (e.g. inside an enclosure) and leaving it powered up (but not necessarily recording) will allow it to be used at sub zero temperatures. To offer the best performance in low and high temperature environmental conditions, an insulated case can be used with a fan, which is thermostatically controlled to switch on when the temperature rises above 10°C. The fan speed can be increased or decreased based on a thermal feedback circuit (analogue thermostat).

Shock and Vibration

Due to the nature of hard disk drives it is essential that the X200 is isolated from vibration and shock as much as possible.

Consideration should be paid to the mounting position so that the levels of shock and vibration that may be encountered are minimized.

In situations where some exposure to shock and vibration are unavoidable it is strongly advised that the T408 Anti-Vibration System is used. This system is specifically designed to isolate the X200 from structure borne shock and vibration. Further details and fitting instructions can be found in the Anti-Vibration Kit section of this manual.

EMC

The X200 complies with the relevant EEC, Automotive 'E' Mark and Specification 5 (Emergency Vehicles) EMC standards for this type of product.

Conformity

X200 EMC Conformity (CE Mark)

Meets the European Council Directive 89/336/EEC (EMC Directive) relating to EMC Emissions - EN61000-6-3(2001) and EMC Immunity – EN61000-6-1(2001).

X200 EMC Conformity (E Mark)

Meets the Type Approval requirements of European Commission Directive 95/54/EC.

X200 PITO Specification 5

Has met the requirements of automotive conformance regarding use in Emergency Vehicles.

Recycling

When the product has reached its end of life and requires disposal, recycling instructions are available upon request.

EC Declaration of Conformity (CE)

We Timespace Technology Ltd.
Blackstone Rd
Huntingdon
PE29 6TT
United Kingdom

declare that the

X200 Digital Video Recorder

Meets the intent of the European Council Directive 89/336/EEC referred to as the Electromagnetic Compatibility (EMC) Directive. The product conforms to the following standards which have been listed in the *Official Journal of the European Union*.

EMC

Emissions: EN61000-6-3(2001) EMC Generic Emission Standard for residential, commercial and light industrial. Referring to:

- a) EN55022(1998) Conducted, Class B
- b) EN55022(1998) Radiated, Class A

Immunity: EN61000-6-1(2001) EMC Generic Immunity Standard for residential, commercial and light industrial. Referring to:

- a) EN55024(1998) Information Technology Equipment – Immunity Characteristics
- b) IEC 61000-4-6(2003) RF Field
- c) EN60801-2(1993) Electrostatic Discharge
- d) IEC 61000-4-4 (2004) Fast Transient



.....
Dr ROBERT HEYLEN
TECHNICAL DIRECTOR
27th July 2004



VCA Headquarters
1 The Eastgate Office Centre
Eastgate Road Bristol, BS5
6XX United Kingdom

Switchboard: +44 (0) 117 951 5151
Main Fax: +44 (0) 117 952 4103
Email: enquiries@vca.gov.uk
Web: www.vca.gov.uk

THE UNITED KINGDOM VEHICLE APPROVAL AUTHORITY

COMMUNICATION CONCERNING THE TYPE APPROVAL OF THE COUNCIL DIRECTIVE OF 20 JUNE 1972 ON THE APPROXIMATION OF THE LAWS OF THE MEMBER STATES RELATING TO A TYPE OF COMPONENT WITH REGARD TO RADIO INTERFERENCE SUPPRESSION (72/245/EEC) AS LAST AMENDED BY 2006/28/EC.

Type Approval No: e11*72/245*2006/28*2888*01

EC type-approval mark to be affixed on ESA: 032888

Reason for Extension: To cover: Upgrade directive to 2006/28/EC

SECTION I

0.1 Make (trade name of manufacturer): Timespace Technology

0.2 Type: X200 Digital Video Recorder Family has two versions: X200-16 16 camera version and X200-04 4 camera version:

0.3 Means of identification of type, if marked on the component:: Self-adhesive label

0.3.1 Location of that marking: On centre of underside of product

0.5 Name and address of manufacturer:

Timespace Technology Ltd
Blackstone Road
Huntingdon
Cambridgeshire PE29 6TT
United Kingdom

Name and address of authorised representative, if any: Not applicable

0.7 In the case of components and separate technical units, location and method of affixing of the EC type-approval mark: Self-adhesive label on centre of underside of product



APPENDIX

to EC Type Approval Certificate No: e11*72/245*2006/28*2888*01

concerning the type approval of an electric/electronic sub-assembly
with regard to Directive 72/245/EEC as last amended

1. Additional information

1.1 Electrical system rated voltage: 12V negative ground

1.2 This ESA can be used on any vehicle type with the following restrictions: 12V negative ground

1.2.1 Installation conditions, if any: As per manufacturer's instruction

1.3 This ESA can only be used on the following vehicle types: Not applicable

1.3.1 Installation conditions, if any: Not applicable

1.4 The specific test method(s) used and the frequency ranges covered to determine immunity were (please specify precise method used from Annex 1X): Not applicable

1.5 Laboratory accredited to ISO 17025 and recognised by the Approval Authority (for the purpose of this Directive) responsible for carrying out the test: MIRA Nuneaton

5. Remarks: None

(1) *Delete as applicable*

(2) *If the means of identification of type contains characters not relevant to describe the vehicle, component or separate technical unit types covered by this information document/typeapproval certificate, such characters shall be represented in the documentation by the symbol '?' (e.g. ABC??123??).*



AES

AUTOMOTIVE AND EQUIPMENT SECTION



CERTIFICATE OF CONFORMANCE

Certificate No. - **4275E**

Date - **16 Apr 2010**

Submitted by -

Manufactured by -

**Timespace Technology Ltd
Blackstone Road
Huntingdon
PE29 6TT**

**Timespace Technology Ltd
Blackstone Road
Huntingdon
PE29 6TT**

This is to certify, that a representative example of

Make - **Timespace Technology Ltd**

Model - **Digital Video Recorder X200**

Year - **2010**

Identification No. (V.I.N./Serial) Number -

has met the requirements of Automotive Conformance

Specification **5** Issue **10** (Dec 2007) Class **FULL** pass*

TETRA band passed within appropriate freq ranges

in respect of Electromagnetic compatibility performance.

*(*see reverse of certificate for non-conformance)*

This Certificate is valid for a period (not exceeding 2 years) from the date of issue.

This certificate does not indicate compliance with the Automotive EMC Directive or its amendments

Issued by - **Barend Strydom**

Automotive and Equipment Section
NPIA

Signed -

16 Apr 2010



SYSTEM OVERVIEW

X200 DIGITAL VIDEO/AUDIO RECORDING SYSTEM



X200 DIGITAL VIDEO /
AUDIO RECORDER



REMOVABLE HARD DISK
CARTRIDGE



X201 REVIEWER &
PROGRAMMER

The X200 is a digital video/audio surveillance recorder for use in covert, portable and mobile applications.

Recordings are made on a removable Hard Disk Cartridge inserted in the X200. After the Hard Disk Cartridge has been removed, the recordings can be accessed by connecting the cartridge to a PC, using the USB Interface Kit, (which includes PCLink200, a proprietary reading and archiving software package).

The use of Hard Disk Cartridges other than those supplied by Timespace Technology will invalidate the warranty of the X200 recorder, and will constitute a breach of the X200 operating software copyright.

The X201 Reviewer is used to program the menu settings on X200, to check camera views and to review recordings on the installed X200 Hard Disk Cartridge. Recording will continue during this reviewing process.

The 24-hour clock is used for all times and settings.

WARNING: The X200 Recorder must always be mounted so that there is a free flow of air around it. If it is mounted in an enclosure, it is essential that adequate ventilation is provided, and it is recommended that a fan is incorporated in the enclosure design.

WARNING: If the X200 Recorder is mounted in a vehicle, or otherwise subject to vibration, suitable damping must be built into the mounting.

WARNING: Hard Disk Cartridges are sensitive to shock, vibration and humidity and must be used within operating temperature range as detailed in the X200 specification.

WARNING: It is highly recommended that recording is stopped before power is removed from the X200 to avoid loss of data. It is also recommended to stop recording before the cartridge is removed.

WARNING: Cartridges should be safely removed from Windows operating system environment prior to removing power/usb cable. Data loss or corruption may occur if this is not followed.

Diagrammatic Explanation of Use

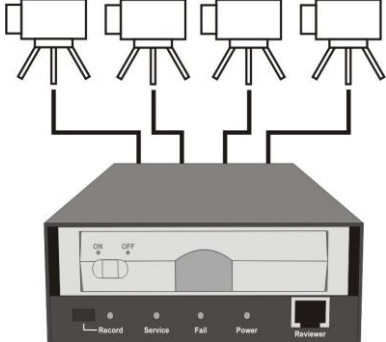

RECORDING

The X200 Digital Video Recorder is used With a removable Hard Disk Cartridge to Record from multiple video and audio sources.

REVIEWING / CONFIGURING

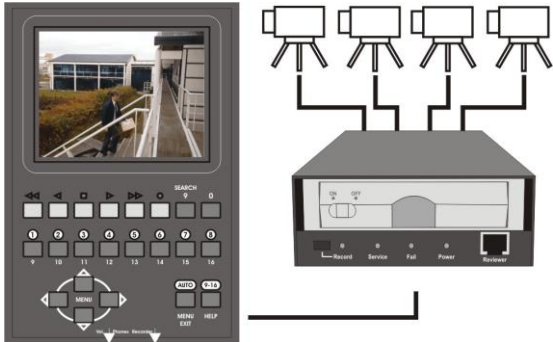

The X201 Reviewer is used for on-site reviewing of video/audio recordings and to configure the optional menu settings of the X200 Digital Video Recorder.

This can also be done via serial connection to a PC.

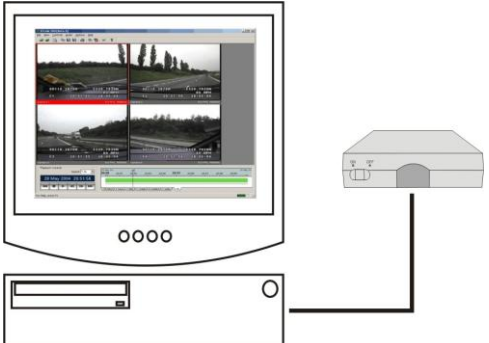

PC REVIEWING / ARCHIVING

The removable Hard Disk Cartridge is connected to a PC (via USB Kit) to analyse, copy or archive video/audio recordings and to download new operating software.

REMOTE OPERATION



A Wireless Local Area Network (WLAN) system can be used to download recordings from the X200 in a vehicle to a PC.

A GSM modem can be used in conjunction with the X200 and RemoteLink software to configure the X200 remotely.

X200 RECORDING TIME CALCULATION

The following table allows the calculation of recording time in hours and other parameters. Fill out 5 of the 6 entries A to F to calculate the missing entry.

Number of cameras		A _____
Number of images/sec for each camera		B _____
Amount of motion (%)		
Enter 100	Full Update Recording	
Enter 80	High Motion Cond. Refresh	
Enter 60	Bus Market Cond. Refresh	
Enter 40	Med Motion Cond. Refresh	
Enter 20	Low Motion Cond. Refresh	C _____
Disk size in GBytes		D _____
Amount of time in Hours		E _____
Resolution (kBytes)		
Enter 30	VV. High	
Enter 25	V. High	
Enter 20	High	
Enter 15	Medium	
Enter 10	Low	F _____

Calculations without audio recording

Amount of time in hours	$E = (27777 \times D) / (A \times B \times C \times F)$
Disk size if you know the time	$D = A \times B \times C \times E \times F / 27777$
How much % motion	$C = (27777 \times D) / (A \times B \times E \times F)$
Number of images on disk	$(100,000,000 \times D) / (C \times F)$

Audio Sampling Rate		
Enter 8000	8 kHz	
Enter 16000	16 kHz	G _____
Audio Channels		
Enter 1	Mono	
Enter 2	Stereo	H _____
Audio Sampling Rate		
Enter 1	8 bits	
Enter 2	16 bits	I _____

Calculations with audio recording

First calculate bytes per second	$M = (A \times B \times C \times F \times 10) + (G \times H \times I)$
Amount of time in hours	$E = 277,777 \times D / M$
Disk size if you know the time	$D = E \times M / 277,777$

A Timespace Footage Calculation tool can be provided upon request by email support@tspace.co.uk

Recommended settings for 'Audio Only' recording are;

- Using the reviewer, navigate and change the following items;
- Normal Recording
 - Camera 1 → 0.1 ips
 - Camera 2-4 → No Recording
 - Audio ON
- Audio Recording
 - Channels → Stereo
 - Check the Input Range is ok for your specific application
- Other, File System
 - File Length → 1 Hour
- Advanced
 - Record Settings
 - Norm / Timer → Full Update

COMPATIBILITY WITH X100 HARD DISK CARTRIDGES

The use of Hard Disk Cartridges other than those supplied by Timespace Technology will invalidate the warranty of the X200 recorder, and will constitute a breach of the X200 operating software copyright.

- 1) **All Cartridges from an X100 can be used in an X200, as long as X100 Operating Software V1.5.0 or later is installed.**
- 2) **All Cartridges from an X200 can be used in an X100.**

The X200 stores its operating system and menu settings internally in non-volatile flash memory whilst the X100 stores its operating system and menu settings on the Hard Disk Cartridge. Therefore all new Hard Disk Cartridges are supplied with the latest version of the X100 operating software already installed so that the cartridges can be used in both the X200 and X100 without modification.

Please note that as the X100 stores its menu settings on the cartridge as well as the operating software, using a new cartridge in the X100 will mean that all menu settings will revert to the factory default settings.

Older cartridges which have only previously been used with the X100 can be used with the X200 without modification as long as the X100 operating system stored on the cartridge is version 1.5 or later. The menu settings on the X200 will not be affected by using the cartridge.

If the X100 operating system stored on the Cartridge is previous to version 1.5 then version 1.5 or later will need to be loaded onto the Cartridge before it can be used with the X200.

It is possible to record both .oba* (X100 file) and .xba (X200 file) on the same cartridge without any compatibility problems. Please note however that the X100 will only list and play back .oba files and the X200 will only list and play back .xba files.

Where loop recording is selected, the X200 records over oldest files first, whether they are .oba or .xba files. The X100 on the other hand will overwrite files in an indeterminate manner (based on their physical location on disk). Consequently if disks are to be moved from an X200 system into an X100 system please ensure that all critical files have been archived onto a PC or write protected on disk.

Resetting the cartridge on the X200 and thus deleting all of the recording files on the disk (all .oba and .xba files will be deleted) will not affect the X100 operating software.

CARTRIDGE COMPATIBILITY AND LABELING

X100 recorders with V1.60 System Software are compatible with cartridges up to and including 160Gb.

To distinguish new 160Gb cartridges from existing cartridges, new T401-160 cartridges will be labeled 'T401-160X' or 'T401-160S'. Existing 160Gb cartridges, labeled 'T401-160' are not compatible with X100 recorders, unless V1.60 System Software is loaded.

Compatibility

Part Number	Cartridge Label	X100 Compatible V1.60	X200 Compatible V1.8.3 or later	Hard Disc Type
T401-120	T401-120 T401-120S	OK OK	OK OK	PATA SATA
T401-160	T401-160 T401-160S T401-160X	X OK OK	OK OK OK	PATA SATA PATA
T401-250	T401-250 T401-250S	X X	OK OK	PATA SATA
T401-320	T401-320 T401-320S	X X	OK OK	PATA SATA
Part Number	Cartridge Label	X100 Compatible V1.60	X200 Compatible V1.8.3 or later	Hard Disc Type
T401-500	T401-500S	X	OK	SATA
T402-80	T402-80 T402-80S	OK OK	OK OK	PATA SATA
T403-64	T402-64 T402-64S	X X	OK OK	PATA SATA

X200 DIGITAL RECORDER



Installation

The X200 can be used free-standing or it can be mounted on a wall or bulkhead.

Power can be applied to X200 either via 12V DC jack socket or 12V screw terminals. **NB: Do not use both power inputs simultaneously.**

The Hard Disk Cartridge (supplied separately) with lock on the front in "Off" position should be inserted into receptacle in front panel of X200 and gently but firmly pushed into place, then lock switched to "On" position.

Mechanical Data

4 x threaded holes are available in the back panel of the X200 for mounting:

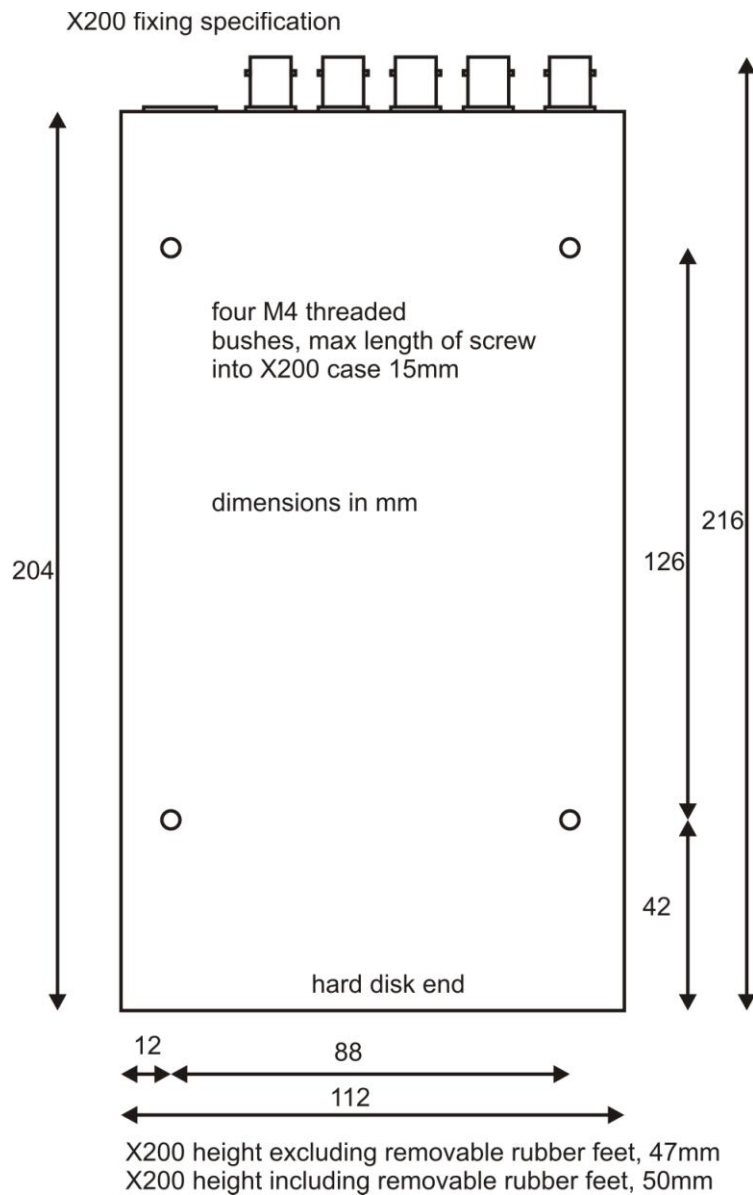

Vehicle installation

Regulated 12V power supply

Feed this 12V power supply to X200 unit and a the cameras. Connect video output from cameras to X200 using coax cable. It is important to provide a low resistance ground path when powering the cameras to avoid video noise.

Wiring

Run a ground and power cable pair from the X200 to each of the cameras and create a star ground point where all the ground cables meet somewhere very close to the ground of the X200. Use the green power block or the 2.1mm DC jack(pin) socket to feed power into the X200.

T408 Vehicle Kit

For use in mobile installations subject to shock and vibration. Please adhere to the following instructions for the installation of the Vehicle Kit. Failure to do so may result in the Mounting System not working correctly.

Inventory of Parts

The Vehicle Kit consists of the following parts -

QTY	Description
4	Wire Rope Mounts
1	Stabiliser Coupling
8	M4 x 12mm Counter-Sunk Hex-Head Screws

In addition you will require a standard 'L' shaped hex key. This is essential, as when all of the other screws have been tightened, there is no room for any other tool to tighten the front lower pair of screws.

Mounting Hole Preparation

Drill four mounting holes to attach the Wire Rope Mounts. If you intend to use the M4 x 12mm screws into blind holes, then the holes will have to be drilled and tapped to accept an M4 screw, with a thread depth of no less than 8mm.

If mounting the Wire Rope Mounts through a metal plate, then longer screws may have to be used in order to allow a washer and nut to be attached on the other side of the plate. The length of these screws will have to be chosen depending on the thickness of the plate and the height of the washer and nut.

Please note that any screw used for mounting the wire rope mounts to an enclosure surface must have an M4 thread and have a counter-sunk hex-head.

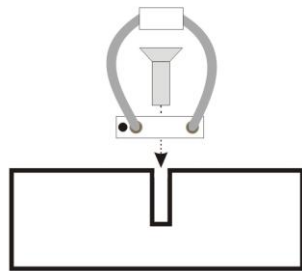

M4 x 8mm Threaded Hole

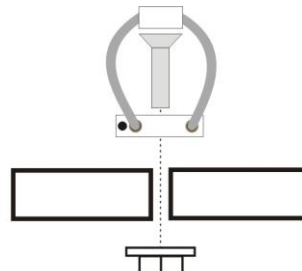

4mm Ø Through-Hole

Mounting Hole Location

The mounting holes must be drilled on 126mm and 88mm centres.

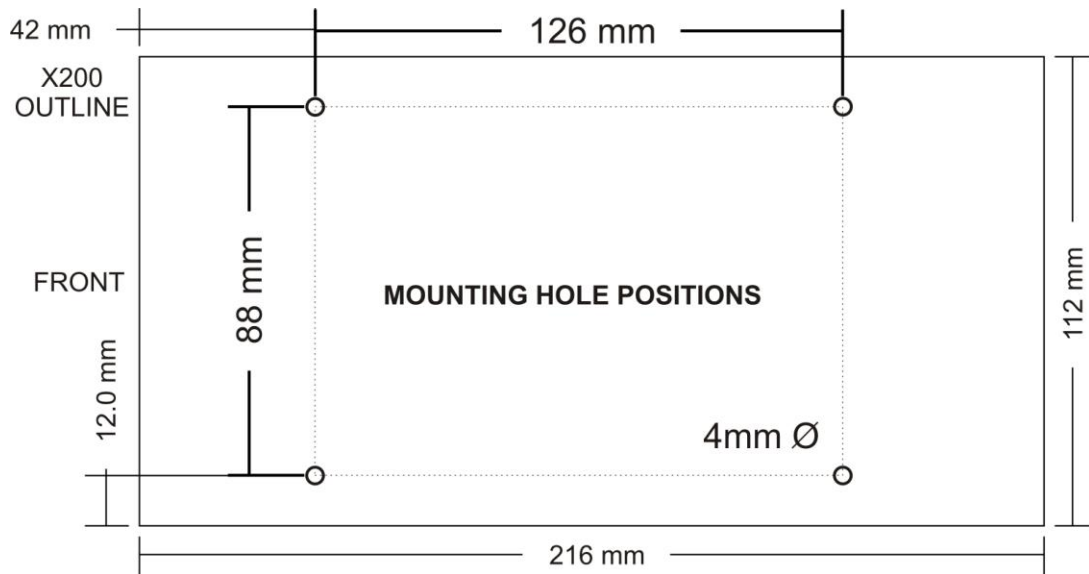

Total Mounting Volume Required

It is necessary to allow a minimum clearance of at least 15mm around the body of the X200 when mounted on the T408 Vehicle Kit. This is to allow free movement of the X200 on the anti vibration mounts and to prevent collision with either the enclosure or peripheral systems due to vertical and lateral movement under extreme shock and vibration conditions.

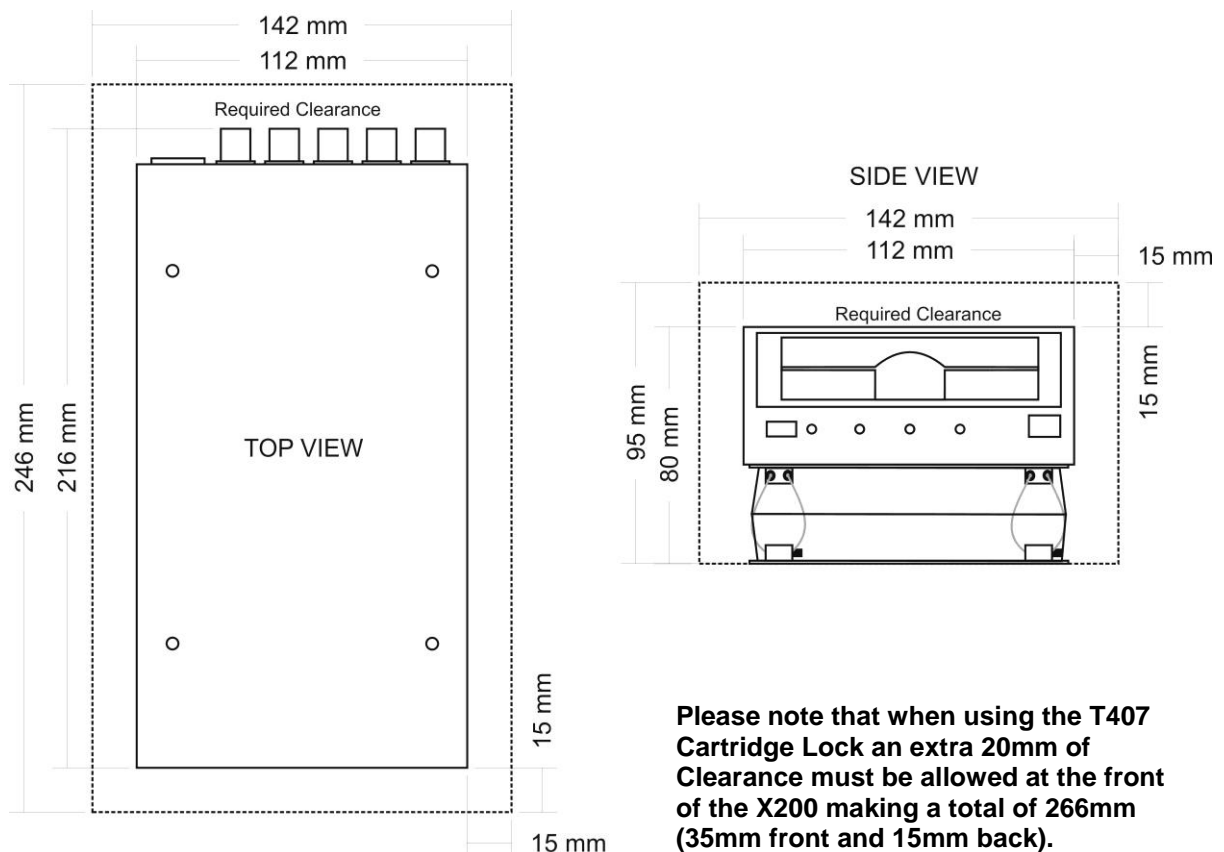

Please note that when using the T407 Cartridge Lock an extra 20mm of Clearance must be allowed at the front of the X200 making a total of 266mm (35mm front and 15mm back).

Cable Installation

Please note that when installing cables to the rear of the X200 it is important not to arrange or clamp them in such a way as to impede the free movement of the rear anti-vibration mounts.

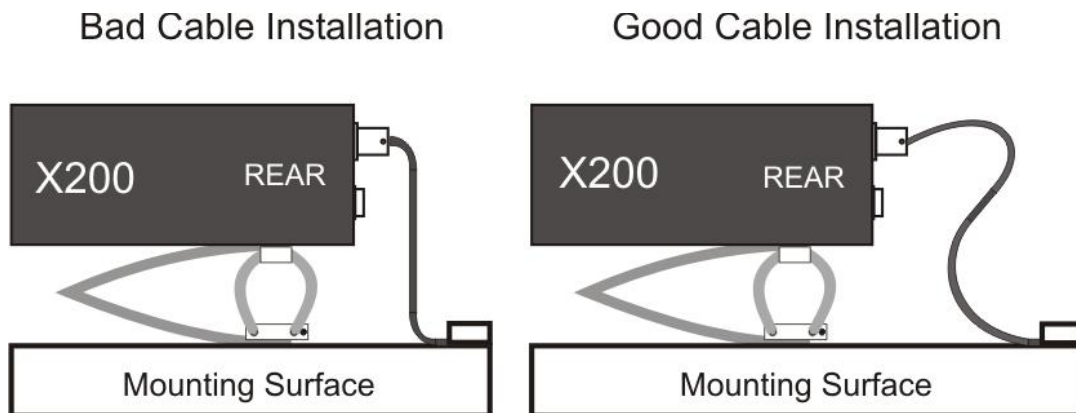

Installation Procedure

It is advised that some form of thread-lock compound should be used on the screws securing the wire rope mounts to both the X200 and mounting surface. This is in order to prevent loosening due to vibration. **WARNING - Ensure only a small amount of adhesive is added to the screw points. Excessive amounts will leak onto the circuit board and damage components.**

- 1) Attach the Wire Rope Mounts to the X200 with four of the countersunk M4 hex-head screws provided and L-shaped hex key. When attaching the rear pair of mounts please ensure that the stabilizer is 'sandwiched' between the mounts and the X200 by aligning the stabilizer holes with the mounting holes in the X200.

Please note that the 'open' end of the C-shaped plastic stabiliser should be attached to the rear wire rope mounts and face backward.

- 2) Once all of the Wire Rope Mounts have been securely attached to the X200, use a pair of countersunk M4 hex-head screws to attach the bottom 'feet' of the front Wire Rope Mounts to the mounting surface/enclosure.
- 3) Secure the lower 'feet' of the rear Wire Rope Mounts to the mounting surface/enclosure using the remaining pair of countersunk M4 hex-head screws and a standard L-shaped hex key. Ensure that the stabilizer is 'sandwiched' between the lower feet and the mounting surface/enclosure by screwing through the Wire Rope Mount feet, then the stabilizer and into the mounting surface/enclosure.

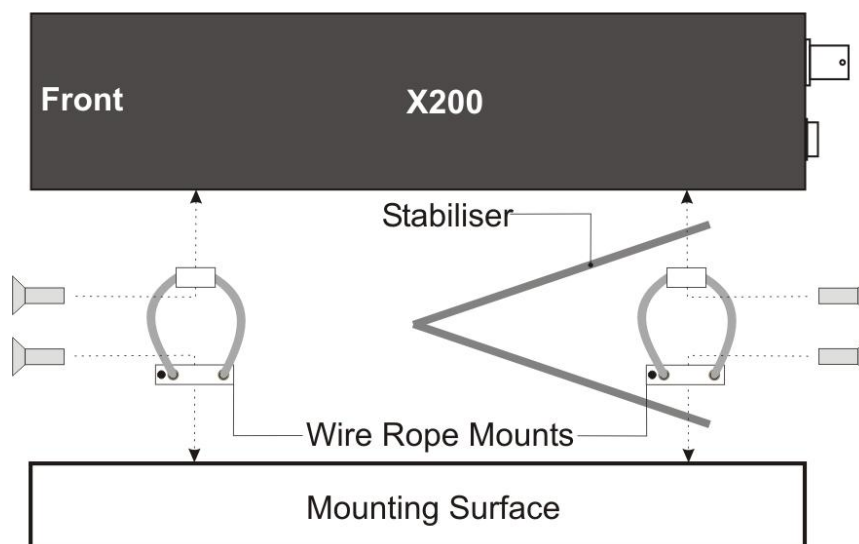

Orientation of Unit

The X200 should be mounted in the following horizontal orientation. This is strongly advised for maximum vibration and shock isolation.

Horizontal

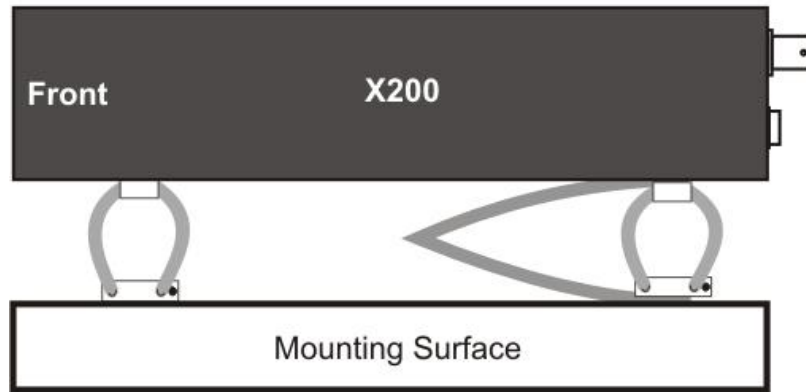

If it is not possible to mount the X200 in the horizontal orientation then the following vertical orientation may be used.

Vertical

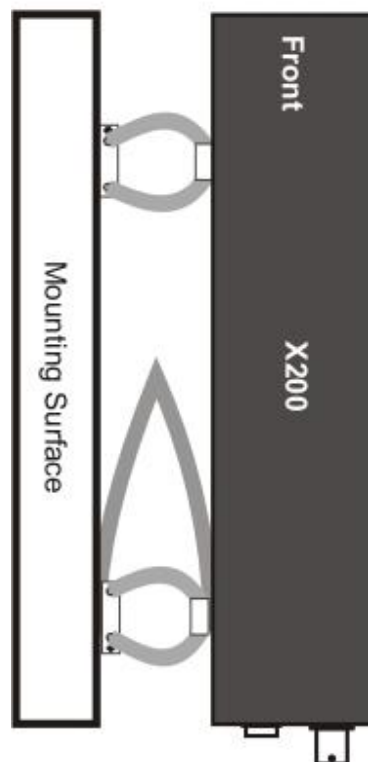

It must be noted however that this vertical orientation is not as effective at isolating the X200 from vibration and shock as the horizontal orientation.

The position of the plastic stabiliser, screw types and assembly order remain the same for this mounting orientation.

The X200 must never be mounted by hanging it upside down from a horizontal surface when using this mounting system.

Connector Specifications and Diagrams

X200-16 Rear Panel

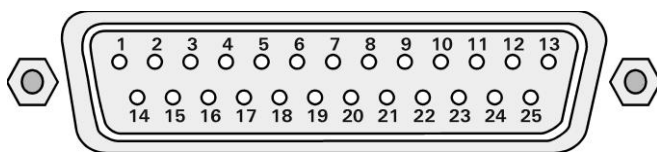
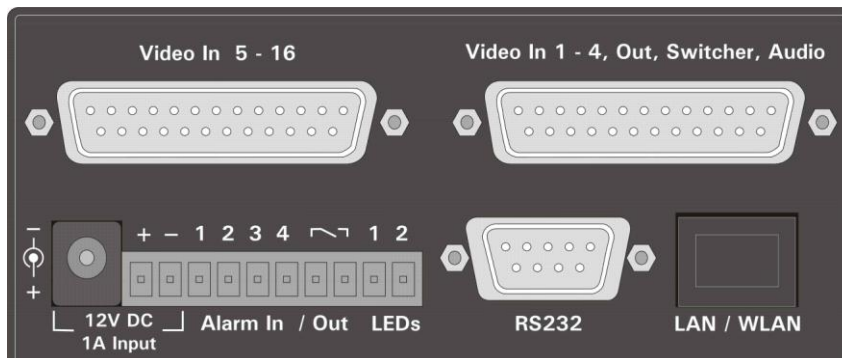

Pin numbering of both 25 Way Male D type connectors on X200 (looking at rear panel).

Video 5 - 16 Connector

Pin		Pin	
1	Video GND In 5	14	Video In 5
2	Video GND In 6	15	Video In 6
3	Video GND In 7	16	Video In 7
4	Video GND In 8	17	Video In 8
5	Video GND In 9	18	Video In 9
6	Video GND In 10	19	Video In 10
7	Video GND In 11	20	Video In 11
8	Video GND In 12	21	Video In 12
9	Video GND In 13	22	Video In 13
10	Video GND In 14	23	Video In 14
11	Video GND In 15	24	Video In 15
12	Video GND In 16	25	Video In 16
13	Not Connected		

Video 1 - 4, Out, Switcher, Audio Connector

Pin		Pin	
1	Video GND In 1	14	Video In 1
2	Video GND In 2	15	Video In 2
3	Video GND In 3	16	Video In 3
4	Video GND In 4	17	Video In 4
5	Video GND Main Out	18	Video Main Out
6	Video GND Switcher Out	19	Video Switcher Out
7	Audio GND Out 2 (right)	20	Audio Out 2 (right)
8	Audio GND Out 1 (left)	21	Audio Out 1 (left)
9	Audio GND In 1 (left)	22	Audio In 1 (left)
10	Audio GND In 2 (right)	23	Audio In 2 (right)
11	Video GND Main Out S-Video Y	24	Video Main Out S-Video Y
12	Video GND Main Out S-Video C	25	Video Main Out S-Video C
13	Not Connected		

X200-16 Cable Harness Recommended Specification

A common cable harness can be used for both 25 Way D type connections on the X200-16

Connector 25 Way Female D type
 Shell Recommended max overall width 56mm (the two 25 way connectors are 57mm apart)
 Cables 12 individual RG179 cables of suitable length.

Connections	Shield pin	Core Pin
Cable 1	1	14
Cable 2	2	15
Cable 3	3	16
.....		
Cable 12	12	25

Pin 13 not connected.

In order to meet the EMC standards with which the X200 is compliant it is important that shielded cables are exclusively used. All of the signal grounds should be commoned inside the D-Type connector and connected to a metal back-shell in order that the cable run and D-Type connector are shielded.

X200-04 and X200-16 Input/Output Connector

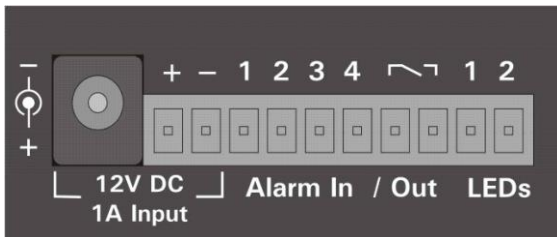

Connect power input to either + - terminals or to 2.1mm jack socket (requires 2.5 x 5.5 x 9.5mm DC example – www.uk.farnell.com part no. 224923)

Connect alarm inputs 1, 2, 3 and 4 to - terminal if closed, leave open circuit if open

Connect alarm output to Out terminal pair (0.13amp).

Connect LED 1 between + and terminal LED 1, including a series resistor to limit current.

Connect LED 2 between + and terminal LED 2, including a series resistor to limit current.

Terminals LED 1 and LED 2 are high impedance (LAMP/LED off) or 0V (LAMP/LED on)

Input/Output connector – www.uk.farnell.com part no. 9632794.

LED outputs 1 and 2 can be menu assigned to duplicate any of the 4 front panel LEDs (power, record, service and fail).

X200-04 and X200-16 Ethernet Connector



Connect via a normal Ethernet cable (straight i.e. pins 1-1, 2-2, 3-3 etc.) to Ethernet hub, switch, router or wireless LAN adaptor.

Internal Connections: 1 Tx+, 2Tx-, 3 Rx+, 4 NC, 5 NC, 6 Rx-, 7 NC, 8 NC

X200-04 and X200-16 RS232 Connector



The X200 has a 9 way male D-type connector (DB9) which can be used to support 1 or 2 RS232 peripherals.

Conventional Cable

Using a conventional cable (DB9 male to DB9 female straight through (1-1, 2-2, 3-3 etc.)) the X200 can be connected to a modem:

Pins on the X200

Pin			→ X200 output	← X200 input
3	TD	Transmit Data	→	Serial Data (0 = 10V, 1 = -10V)
2	RD	Receive Data	←	Serial Data (0 = 10V, 1 = -10V)
7	RTS	Request to send	→	Handshaking (please send signal = 10V)
8	CTS	Clear to send	←	Handshaking (please send signal = 10V)
4	DTR	Data terminal ready	→	X200 outputs 5V (data terminal is ready)
6	DSR	Data set ready	←	Ignored by X200
1	DCD	Data carrier detect	←	Used to detect that modem is on air (=10V)
9	RI	Ring Indicator	←	Ignored by X200
5	GND	Ground		

Proprietary Dual RS232 Connection

This supports the connection of two RS232 peripherals such as GSM modem and GPS (Global Positioning System).

RS232 port 1 (Modem)

Pin			→ X200 output	← X200 input
3	TD	Transmit Data	→	Serial Data
2	RD	Receive Data	←	Serial Data
7	RTS	Request to send	→	Handshaking
8	CTS	Clear to send	←	Handshaking
1	DCD	Data carrier detect	←	Used to detect that modem is on air (10V)
5	GND	Ground		

RS232 port 2 (other device)

4	5V	Power supply for GPS unit (500mA max)	
6	Ignored by X200		←
9	RD	Receive Data	← Serial Data
5	GND	Ground	

X200-04 Rear Panel

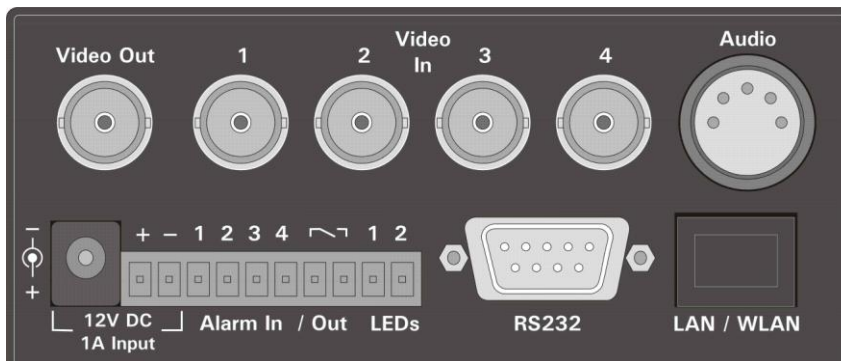

- 1 BNC video output
- 4 BNC video inputs

Audio Connector

5 pin 180° female DIN connector (DIN 41524)

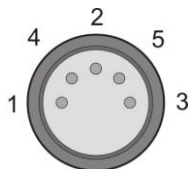

Pin

- 1 Audio input 1 (left)
- 4 Audio input 2 (right)
- 2 Audio GND
- 5 Audio output 2 (right)
- 3 Audio output 1 (left)

The audio signals are at line level

A 5 pin DIN to 4 way RCA phono harness can be readily purchased from a number of suppliers. Suggested search via www.google.com for "5 pin din to rca phono audio".

A locking connector could be used to secure the DIN in place. Recommend parts are;

Locking Nickel plated finish, Deltron part number 590-0500, **Farnell** part number **119-3833**
Locking Black finish, Deltron part number 591-0500, **Farnell** part number **119-3828**

2.1mm jack socket (requires 2.5 x 5.5 x 9.5mm DC example – www.uk.farnell.com part no. 224923)

X200 Front Panel

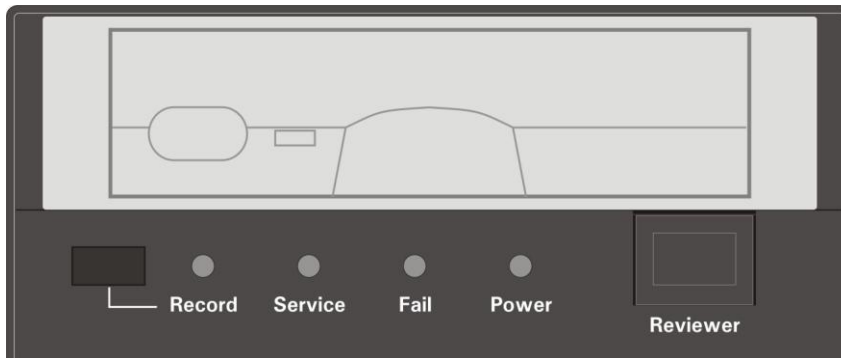

Record Button

Turns Normal recording on and off. Can be menu disabled.

LED Indicators

Record LED

Illuminated when the X200 unit is recording.

Service LED

Illuminated when any of the service conditions are met. Please refer to the Service and Fail LED section of this manual for further details.

Fail LED

Illuminated when any of the fail conditions are met. Please refer to the Service and Fail LED section of this manual for further details.

Power LED

Illuminated constantly while power is supplied to the X200.

At Power On

All four LED's will illuminate whilst the X200 initialises and will remain lit during system check (menu disabled) until the unit is operational. Once operational only the Power LED will remain illuminated unless recording is taking place.

At System Reboot

If the Hard Disk Cartridge is switched off and then on (or replaced) or the Load System Upgrade has been performed the X200 will reboot. In this case as per at power on all four LED's will illuminate whilst the X200 initialises and will remain lit during system check (menu disabled) until the unit is operational. Once operational only the Power LED will remain illuminated unless recording is taking place.

Reviewer Connector



Connect X101 or X201 reviewer to X200 using this socket. Signals for this connector are as follows:

- | | |
|---|------------------------|
| 1 | Video out |
| 2 | Video ground |
| 3 | Audio ground |
| 4 | RS232 Rx |
| 5 | RS232 Tx |
| 6 | Audio out (line level) |
| 7 | Power ground |
| 8 | 12V |

Service and Fail LED

The Service and Fail LED's on the X200 front panel give a positive indication in certain circumstances where a system fault may have occurred.

If the Service LED is lit then the system will most likely be functional but may not be performing as intended. The system should be checked and any remedial action taken as soon as possible.

If the Fail LED is lit then the system will not be functioning. The Fail LED only lights when the X200 is unable to read or write to the installed Hard Disk Cartridge. If the Fail LED is illuminated then the Hard Disk Cartridge should be replaced immediately and the X200 system checked for any possible causes of the disk failure.

These conditions are listed in the service log which can be viewed in the statistics menu by selecting 'View Service Log'. The Service LED will remain lit and the problem which caused the Service LED to light will be listed in the log until the log is reset by selecting 'Reset Service Log'.

SERV:11:CAM:DISCONNECTED CAMERA dd

- *dd* indicates the camera which is disconnected.
- This message indicates that the unit has failed to record 1000 consecutive images for the specified camera.
- The Service LED is illuminated when this event occurs.
- *Suggested Remedy:* Check and reconnect/replace the disconnected camera.

SERV:13:SYS:FPS WHEN RECORDING < ddd

- *ddd* indicates the requested frame rate.
- Whenever a recording file of greater than 60 seconds duration is closed the system checks the number of video frames it contains. If it is less than half that specified in the recording parameters then this service condition is raised.
- The Service LED is illuminated when this event occurs.
- *Suggested Remedy:*
 - Check for decoder failure messages at start up
 - Ensure that Ethernet transfers are not taking place while recording.
 - The disk may be responding slowly – try another disk
 - For installations with only a few cameras this could be caused by a disconnected camera.

SERV:15:SYS:TIME ERROR ddd

- *ddd* indicates the time error in seconds.
- When the unit's time is set via the network it is checked against the system's current time. If the error is greater than 10 seconds then this service condition is raised.
- The Service LED is illuminated when this event occurs.
- *Suggested Remedy:* Before synchronising the system time check that it is set accurately to within 10 seconds.

SERV:17:SMS:MODEM SEND ERROR

- If a connected GSM modem fails to send a SMS (short message service) message then this service condition is raised.
- The Service LED is illuminated when this event occurs.
- *Suggested Remedy:* Check the connected modem is working correctly.

SERV:35:EXT: xxxxxxxx

- xxxxxxxx is the message received over the serial port.
- One of the remote commands accepted over the serial port is #LOG. This allows users to insert their own messages in the service log.
- The Service LED is not illuminated for external service log entries.

FAIL:96:HDD:READ FAILURE dddd

- If the unit attempts to read from the hard drive and is unable to do so then this fail condition is raised.
- The Fail LED is illuminated when this event occurs.
- *Suggested Remedy:* The advanced menu page allows the user to specify a daily quota of disk errors. Either increase the allowed failures or replace the disk.

FAIL:97:HDD:WRITE FAILURE dddd

- If the unit attempts to write to the hard drive and is unable to do so then this fail condition is raised.
- The Fail LED is illuminated when this event occurs.
- *Suggested Remedy:* The advanced menu page allows the user to specify a daily quota of disk errors. Either increase the allowed failures or replace the disk. This error may also occur if a cartridge is removed whilst the X200 is recording. Ensure recording is stopped before removing the cartridge or power.

SERV:63:USR:LOG RESET

- This is the only service message entry in the service log after a user reset has been performed.
- No LEDs are illuminated as a result of this service log entry.

The service log should only be reset once the cause of the problem has been verified and rectified.

Note – Fail 96 and 97 may appear as 32 and 33 in older X200 software.

Programming

The configuration of the X200 is by the menu system, this is accessed using the X201 Reviewer. Please refer to the section on the X201 Reviewer for details of its use.

Connect Data Link Cable (supplied with X201 Reviewer) from socket marked "Reviewer" on X200 to socket marked "Recorder" on X201. This connection will provide power and video to X201 from X200.

To enter Menu System press any of the four MENU arrow buttons. To exit the Menu System or to move back up a level press the MENU EXIT button.

The menu system can also be configured via RemoteLink PC software connected to the X200 via a GSM or serial interface.

Help Screens

Throughout the menu system, every item that the cursor points to has a Help screen. Place the cursor on the line requiring explanation and press the HELP key on the X201 front panel. Use any key to cycle through the screens for that line.

Help screens are available for each menu heading and for all items contained within the menu.

The help system is very comprehensive and it is strongly recommended as a reference to both new and experienced users.

Software Updates

Occasionally software improvements are made to X200 and a new version of software is made available. The software takes the form of a .xos file. Follow these steps to install new software:

1. Delete all recordings on the Hard Disk Cartridge using the reset menu.
2. Using the USB interface kit copy the new .xos file from the PC to the Hard Disk Cartridge. (example file name – X200.V1.8.4.xos)
3. Right click the .xos file on the Hard Disk Cartridge and select properties.
4. Left click to tick the 'Read-only' box at the bottom of the properties window and click OK.
5. Insert the Hard Disk Cartridge into the X200 and stop it recording if it is currently doing so.
6. Go to OTHER MENU > ADVANCED MENU in the X200 menu system.
7. LOAD SYSTEM UPGRADE – This loads a new version of the X200 operating system from the Hard Disk Cartridge.
8. Check the software version in the statistics menu to verify the new version has been loaded.

Note - all settings on the X200 will be reset to defaults when a software update is performed.

WARNING – X200 may become unusable if power to the unit is lost during a software upgrade.

- **SAVE SYSTEM UPGRADE** – This saves the X200 operating system and current menu settings to the Hard Disk Cartridge as a .xos file.

The Cartridge can then be used as a master to set up another X200 with the same software version and menu settings. Use LOAD SYSTEM UPGRADE on the other X200 with the master Cartridge inserted.

Save User Settings

The X200 has a function to allow user defined settings to be default, even if the X200 is reset.

Type **108723** using the numbers on the reviewer. A hidden menu will appear with 2 options;

1. Save to User Defaults - This will save any settings changed as default for that unit. If the Restore defaults option is used in the Advanced menu, all settings will go back to this and not the factory defaults.
2. Restore Factory Defaults – Restores factory defaults. Any user settings will be lost.

Language Selection

By default the X200 menu system is displayed in the English language.

If the user requires that the menu system is to be displayed in a language other than English, Timespace Technology can provide a language template file which the user can translate and return to Timespace Technology for incorporation into the X200 software. This will allow all text displayed on the X201 Reviewer to be in the users preferred language.

Any incorporated languages are selected in the Reset System Menu with the X200 having to be power cycled before the new language settings will take effect.

PAL/NTSC Switching

Introduction

From software version 1.2.0, the X200 offers the ability to switch between the different video standards; PAL and NTSC.

- **PAL** (*Phase Alternating Line*) is the standard used in most European countries with the exception of France. The X200, when configured to use PAL, offers a maximum capture rate of 25 fields per second.
- **NTSC** (*National Television Standards Committee*) is the standard used in the United States of America. The X200, when configured to use NTSC, offers a maximum capture rate of 30 fields per second.

When configured to use one of these standards, the X200 must use it exclusively. This means that cameras of different types cannot be mixed on the device's inputs.

Note that if the unit is configured for PAL and an attempt is made to play back NTSC recordings, the image will appear vertically 'squashed'. Similarly, if the unit is configured for NTSC and an attempt is made to playback PAL recordings, the image will be clipped.

Switching Video Standards

To switch between the required video standard, the user must configure the unit using the RECORDING SETTINGS menu. This is shown below:

```
RECORDING SETTINGS
>OPTIMISE FOR CAMERAS:  MULTIPLE
RECORDING MODE FOR:
  NORM / TIMER:  COND. REFRESH
  ALARM / SHOT:  FULL UPDATE
VIDEO STANDARD:      PAL
COLOUR DISCRIMINATION: AUTO
```

After moving the cursor down the Video Standard line, the left and right menu keys can be used to select between PAL and NTSC. Once the appropriate selection has been made the unit must be power-cycled before it comes into effect. During the power up sequence, the X200 will briefly display the software version installed along with the configured video standard.

File System

The X200 uses a proprietary file type with the file extension .xba

Images from multiple cameras along with audio, GPS and other data are stored in these files. The images are compressed using MPEG2 data compression in either non-predictive (full update) mode or predictive (conditional refresh) mode. For security and optimisation reasons .xba files can only be viewed on a PC using the proprietary PCLink200 software.

For most applications there are two types of normal recording available, loop and single pass.

Loop Recording

By selecting LOOP RECORD from the RECORDING MODE option in the file system menu.

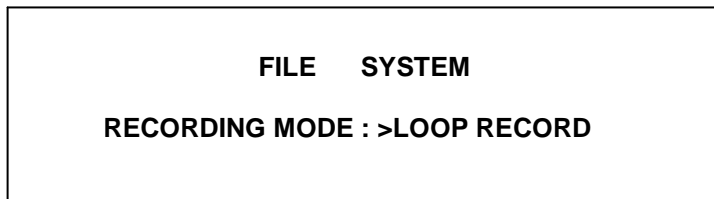

This will set the X200 to automatically delete oldest recordings first when the Hard Disk Cartridge is full (with the exception of write-protected files). The record position is stored and any playback will not affect the current record position (this is in contrast to a VHS tape).

Write-protection can be used to keep Alarm recordings but loop the background (Normal) recording.

Single Pass Recording

By selecting SINGLE PASS from the RECORDING MODE option in the file system menu.

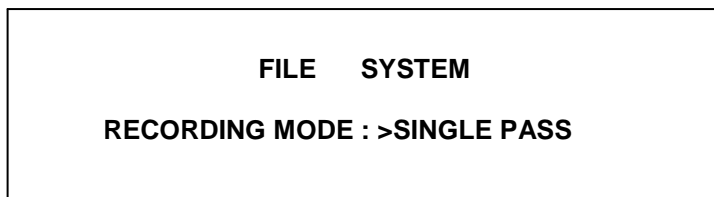

The X200 records until the Hard Disk Cartridge is full and then stops. Recordings may be deleted in the RESET menu or loop recording enabled so that the oldest files will be overwritten first.

Transferring Images to Video Tape

It is possible to transfer recorded footage from an X200 to a video recorder.

Connections

X200-04

The X200 composite video out BNC connector marked 'Video Out' on the rear panel of the X200-04 is connected to the video recorder's BNC composite video input using a BNC-BNC lead. If the video recorder does not have a BNC connector for video input then it is possible to use a suitable adaptor (for example BNC to RCA) as long as the video recorder input is of a composite video type.

X200-16

The 'Video Main Out' and 'Video GND Main Out' on the 25 way male D-type connector on the rear panel of the X200-16 are connected to the signal and GND connections of the composite video input of the video recorder with an appropriate lead.

Recording

Connect the X200 video out to the video recorder's video input using a suitable lead. Insert a suitable tape into the video recorder and rewind / fast forward until it is in the desired recording position.

Using an X201 reviewer select the file to be transferred from the X200 by using the files menu. Scroll through the file list until the required file is found and then press the right menu button next to the file so that it appears on the screen of the X201 Reviewer.

Once selected, the footage will automatically begin to play, press the stop button immediately to avoid missing the first part of the footage. The footage may be rewound if necessary using the rewind control on the X201 (please refer to the chapter on the X201 Reviewer for specific details on playback controls). If a different camera view is required then this can be selected by pressing the appropriate number key on the X201 Reviewer relating to the camera input number on the X200.

When ready press record on the video recorder and then press play on the X201 Reviewer to restart the footage from the X200. The selected camera view from the file should now be seen playing on the X201.

When the file has been recorded press stop on the video recorder and on the X201 reviewer.

Video Compression

The X200 records images, audio, GPS and other data into 10 minute or 1 hour proprietary format files ending with the .xba file extension. A trade-off between image quality and file size can be made by selecting from the five levels of video quality: low, medium, high, v. high and v.v.high. The low setting uses greater compression than the high settings and consequently less disk space is used.

As image quality rises however so does the resultant file size so a decision will have to be made as to the level of image quality needed and the length of recording required to be stored on any given size of Hard Disk Cartridge.

Non-predictive compression (full update)

In the Advanced Menu the user can select between two compression styles. The first, "Full Update Recording" means that a full image is stored every time. Each image stands alone in its own right and uses no prediction from previous images – the recording type is termed non-predictive. The advantage of full update recording is that each image is independent and free from any inter-image distortion. The images can also be searched easily during playback. The disadvantage is that no use is made of any similarity between successive images and the compression performance can be up to 5 times worse (but typically 3 times worse) than conditional refresh recording.

Predictive Compression (conditional refresh)

With conditional refresh recording the X200 stores a full image followed by a sequence of partial images for each camera. When the file is searched, the full image (known as the keyframe) is used as a starting point for playback. The X200 uses a powerful algorithm that detects motion and for each partial image, only updates areas of the image that require it. Partial images may be 1/10th the size of the full images when there is little motion in a scene. There is no cumulative error (which can occur in some MPEG implementations) and the difference between full update recording and conditional refresh recording is designed to be imperceptible. The advantage of conditional refresh recording over full update recording is the compression performance is superior (typically 3 times).

The system defaults to using conditional refresh for normal and timer recording and full update for shot and alarm recording.

Audio

The X200 has two line-level audio input and output channels. Connection to the X200 is via a 5 pin 180° female DIN connector (DIN 41524) on the rear panel of the X200 which is detailed in the Connector Specifications section of this manual.

The two input channels can be assigned to all cameras or a single camera in order to associate recorded sound with the appropriate cameras and images for a particular installation.

The audio channels can be played back individually or together when viewing footage in PCLink200 PC software. They can also be disabled during playback.

The X201 Reviewer can also be used for audio playback through its built in speaker. The audio signal is carried to the reviewer via the RJ45 reviewer cable, no other connections are necessary. It must be noted that at present playback via the X201 is in mono via channel 1 only.

The audio inputs on the X200 Recorder are line-level. Therefore some microphones will require the use of a dedicated preamplifier in order to raise their very low levels of output to line-level. The X200 is configurable so that the line-level input range can be set from 0.12 – 2.0Vrms.

For detailed information on configuring the audio settings in the X200 please refer to the Audio Recording Menu in the Menu System section of this manual.

2 Channel audio recording with 2 microphones and a pre-amplifier.

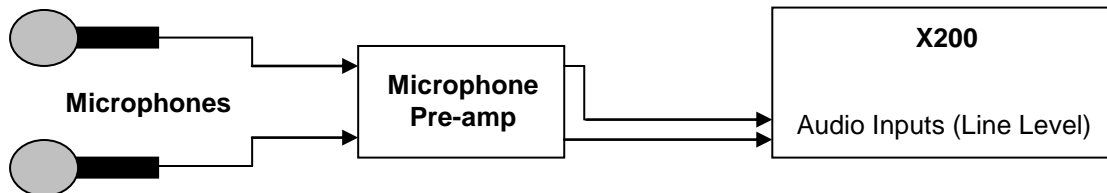

If the X200 is to be used for 'Audio Only' recording, please see recommended settings on the X200 Recording Time Calculation page.

PC Access Precautions

It is important to understand that the X200 file system is a subset of the PC FAT32 file system. The PC will access the X200 disk cartridges with no problems but the X200 will not be able to read every FAT32 file system written by the PC.

Permitted on a PC

Reading the .xba files

Modifying the write-protect status of files

Performing disk utilities that read the disk (e.g. Scandisk) but do not modify disk

Not Permitted on a PC

All write accesses to the disk if it is to be reused in an X200. These include:

Formatting the disk on PC (including any Disk Manager MBR checks/fixes)

Defragmenting the disk

Deleting files

Renaming files

Generating new files

Creating a recycle bin on the disk

PC Access Network Ports

PCLink200 uses UDP port **69** (standard TFTP port).

XCommunicate uses UDP port **69** (standard TFTP port).

RemoteLink uses UDP port **5465**.

LANLink uses UDP port **69** (standard TFTP port).

Time Adjust uses TCP port **8463** (can be configured within the X200 menu system).

Security measures on the network such as encryption and MAC address filtering may need to be adjusted in order to achieve this. Also security applications such as Norton and Symantec on the PC may need to be configured to allow the PCLink Suite applications to operate correctly.

Any installed network or local PC firewalls may have to be instructed to allow the use of this port to prevent communication problems between the PC and the X200.

The Windows Vista firewall may block the X200 responses in PCLink and therefore show as "no reply". To add a specific rule which fixes PCLink's ping reply problems in Vista:

Open the Windows Firewall with Advanced Security within Windows Vista.

1. Click Inbound Rules on the left tree then and click New Rule in the Actions Pane on the right.
2. Click Custom and click Next.
3. Click All programs and click Next.
4. For Protocol type, select ICMPv4.
5. Click Customize button.
6. Click Specific ICMP types, then for 'Type 0', 'code Any', click Add at the bottom. Click OK, and then click Next.
7. Under Which local IP address does this rule match? and for Which remote IP address does this rule match click either Any IP address or These IP Addresses. If you click These IP addresses, specify the IP addresses and click Add, then click Next.
8. Click Allow the connection, and then click Next.
9. Under When does this rule apply?, click the active profile, any or all profiles (Domain, Private, Public) to which you want this rule to apply, and then click Next.
10. For Name type a name for this rule and for Description an optional description. Click

Finish.

Watermark

The X200 uses a fragile watermark. Any modification to the image data will destroy the watermark. The image data that makes up the image set is passed through a function that generates a "magic number" or hash code from the images. The terms hash code and watermark are synonymous. A hash code is created automatically by the X200 for each image set and is then highly encrypted and stored in the information block.

The hash code can be de-encrypted and regenerated by passing the image data back through the function i.e. in a watermark checking program. If the hash code obtained matches the hash code stored in the information block, the image data has not been altered or modified in any way. The watermark is "destroyed" when the hash code stored in the information block and the hash code of the data do not match.

The watermark is always on on the X200 i.e. all recordings have the watermark embedded in real-time as the footage is laid to disk, it cannot be turned off. Within PCLink200, you can turn the display of the watermark on/off - Goto Tools>Preferences - there is a pull down menu for the position of the watermark on the screen, by default it is off within PCLink.

Technical Information

Hashing function: MD5

Encryption function: 64 bit DES

Sequencing

In addition to every image being protected by the Watermark, each consecutive image and file have their own unique sequence numbers. This protects any images being removed from a file and protects any files being removed from a sequence of files.

Watermark / Sequencing report

Within PCLink200, a report can be produced against an image, file and/or sequence of files.

PCLink will analyse the data against the encrypted hash and analyse the data's sequence numbering. If any images have been modified, any images removed or any files removed, PCLink will identify them and report accordingly.

Note – The new sequencing feature was introduced with version 1.8.3 of X200 software and V6.3 PCLink software.

GPS

The Global Positioning System (GPS) is a worldwide radio-navigation system formed from a constellation of 24 satellites (placed in orbit by the US Department of Defence; the first was launched in 1978) and their ground stations. Using accurate timing information, a GPS receiver (GPSr) is able to calculate its position using triangulation.

Anyone with a GPSr can use the system to determine their position anywhere in the world with an accuracy of around 15 metres.

The accuracy is determined by the quality of the satellite signals and the number of them 'in sight'. The GPSr must be positioned so its antennae have a clear line of sight of the sky – obstructions such as foliage and reflected signals in built-up areas can reduce the accuracy.

NMEA-0183 Interface Standard

The National Marine Electronics Association (NMEA) develops and maintains a number of standards related to the marine electronics industry.

The NMEA-0183 Interface Standard defines electrical signal requirements, data transmission protocol and time, and specific sentence formats for a 4800-baud serial data bus. Each bus may have only one talker but many listeners. The *X200 Digital Video Recorder* supports GPS receivers that are NMEA-0183 compliant.

GPS Mice

A number of GPS receivers on the market are commonly referred to as *GPS Mice* because they consist of a GPS engine (GPS receiver and embedded antenna) in a compact case with a single power/data cable. Once powered up these devices send out the GPS data over the serial data connection using the NMEA-0183 protocol standard.

Since the *X200 Digital Video Recorder* provides +5V power out to the GPS mouse, only those which operate at this voltage and draw no more than 200mA should be used. The *X200 Digital Video Recorder* has been tested with the following GPS receivers:

- Garmin GPS16 LVS & GPS18 LVC & **GPS18x LVC**
- RoyalTek Sapphire Serial GPSr
- Fortuna U2 Smart GPS

Note – When using the Garmin GPS18 LVC the X200 baud rate must be set to 192,00. When GPS is used in conjunction with the XP200 accelerometer, it must be set to 192,00 as that is the baud rate of the XP200.

Configuration

Connection

The GPS receiver is connected to the *X200 Digital Video Recorder* through the RS232 port. The diagram below shows the 9 way D-type connector viewed from the back of the *X200* and details those pins to be used for the serial data connection and the +5V supply to the GPS receiver.

Note that the +5V supply is only intended to provide power to a GPS receiver with a current consumption of no more than 200mA.

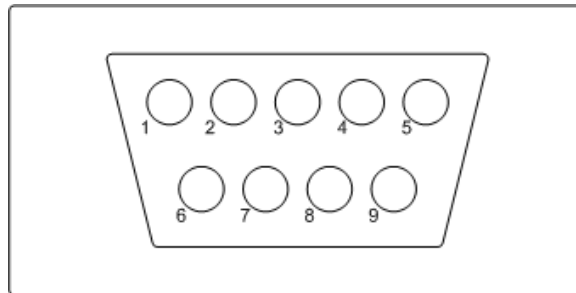

RS 232
(9 pin male d-type)

GPS Receiver Connections

<i>Pin</i>	<i>Connection</i>
<i>4</i>	<i>+5V supply</i>
<i>5</i>	<i>0V</i>
<i>9</i>	<i>Data</i>

X200 GPS Options

Configuration of the X200's GPS options is done via the menu system accessed using a X201 reviewer. The GPS menu option presents the user with a number of options allowing the embedding of GPS position and speed and the units to be used.

If no valid GPS signal is being received then the X200's GPS menu page is similar to that shown below:

```

| GPS |
  

EMBED GPS POSITION:  >YES
EMBED GPS SPEED:   YES
SPEED UNITS:       MPH
  

SYNC CLOCK WITH GPS: YES
GPS BAUD RATE:     4800 bps
  

GPS NOT CONNECTED
```

Or, if valid GPS data is being received, it is displayed towards the bottom of the screen:

```

| GPS |
  

EMBED GPS POSITION:  >YES
EMBED GPS SPEED:   YES
SPEED UNITS:       MPH
  

SYNC CLOCK WITH GPS: YES
GPS BAUD RATE:     4800 bps
  

00011.8464W      5220.5986N
 18 MPH
```

This option determines whether the serial data from the GPS receiver will be recorded by the *X200 Digital Video Recorder*. Note that if no GPS data is received by the X200 (because no functional GPS receiver is connected) then there will be no data recorded either.

If a GPS receiver is connected but satellite lock has been lost then it is still possible to record the data but it will not indicate position, speed, date or time and the actual content may vary according to the type of GPS receiver employed.

Embed GPS Position

Selecting *YES* to 'EMBED GPS POSITION' will cause the position information to be embedded in the recorded image.

Embed GPS Speed

Selecting *YES* to 'EMBED GPS SPEED' will cause the speed information to be embedded in the recorded image.

Note that speed and position information will only be embedded in the video image when the GPS signal is valid and the position can be calculated.

Speed Units

Select either *KPH* for kilometres per hour or *MPH* for miles per hour.

Sync Clock with GPS

The *X200 Digital Video Recorder* includes a clock which is used to timestamp recording files and overlay the date and time on recorded images. Although accurate, the system can be configured to synchronize the clock with the date and time information received from the GPS receiver.

Synchronization only occurs when the X200 is powered up and before it starts recording. At this time the built-in clock may be corrected by a maximum of 20 seconds if a previous discrepancy has been detected between the internal time and the GPS receiver time.

Local Standard Time

The time received from the GPS receiver is always UTC (Coordinated Universal Time) which is the same as GMT (Greenwich Mean Time). In order to correctly work out the error between the local standard time (used by the X200's internal clock) and that received from the GPS receiver, the system must be set with the correct time zone offset.

GPS Baud Rate

Set the X200 data rate according to the GPS mouse you are using. Rates configurable include; 2400, 4800, 9600 and 19200, 38400 bps.

Note – It maybe necessary to change the baud rate on the GPS mouse and set it to a specific rate inline with the X200 setting. Reference the GPS mouse product instructions to configure the baud rate then power off/on the X200 (whilst connected to the GPS).

Troubleshooting

Satellite Signal Quality

In order to calculate its position, a GPS receiver must be receiving signals from at least 3 satellites and do to so it must have a clear view of the part of the sky in which they are located. **GPS receivers do not work indoors.**

When first powered up the GPS receiver will search for satellite signals. The signal includes information on the position of other satellites and all this information must be received before an accurate position calculation can be made. It can take a minute or two before a valid position can be determined after the GPS has been powered up.

Even when a signal is being received from a sufficient number of satellites, a number of factors can result in the degradation of the accuracy of the calculated position. These include:

- **Atmospheric Delays.** The satellite signal slows as it passes through the ionosphere and troposphere. A model built in to the GPS calculations compensates by an average delay to partially correct this error.
- **Signal Multipath.** This occurs when the satellite signal is reflected before reaching the receiver. The delays caused by the additional travel time can cause errors.
- **Receiver Clock Errors.** The GPS receiver's built-in clock is not as accurate as the atomic clock on the satellites and so slight timing errors can result.
- **Orbital Errors.** Cause by inaccuracies of the satellites' reported position.
- **Satellite Visibility.** The greater the number of satellites that the GPS receiver is able to receive a signal from, the better the accuracy of the calculated position. Buildings, terrain or electrical interference can block the signals.
- **Satellite Geometry.** The GPS satellites are constantly moving, orbiting the earth at a height of around 11,000 miles. Each making at least two complete orbits in any 24 hour period. Ideal satellite geometry occurs when the satellites are located at wide angles relative to each other – poor geometry, when the satellites are close together or in a line, results in poorer accuracy.

GPS Receiver

A simple test to ensure that a 'GPS mouse' is functioning is to connect it to a PC's serial port and use an application such as *Microsoft® HyperTerminal®* which comes as part of the *Microsoft® Windows®* operating system.

HyperTerminal® is a terminal emulator application that can be used to connect to other devices using an RS232 serial port. Other similar applications are available but in each case the serial port to which the GPS receiver is to be connected should be configured to use the following settings:

Baud Rate (bits per second)	4800
Data Bits	8
Parity	None
Stop Bits	1
Flow Control	None

The following display shows *HyperTerminal*[®] being configured with the GPS mouse connected to COM1:

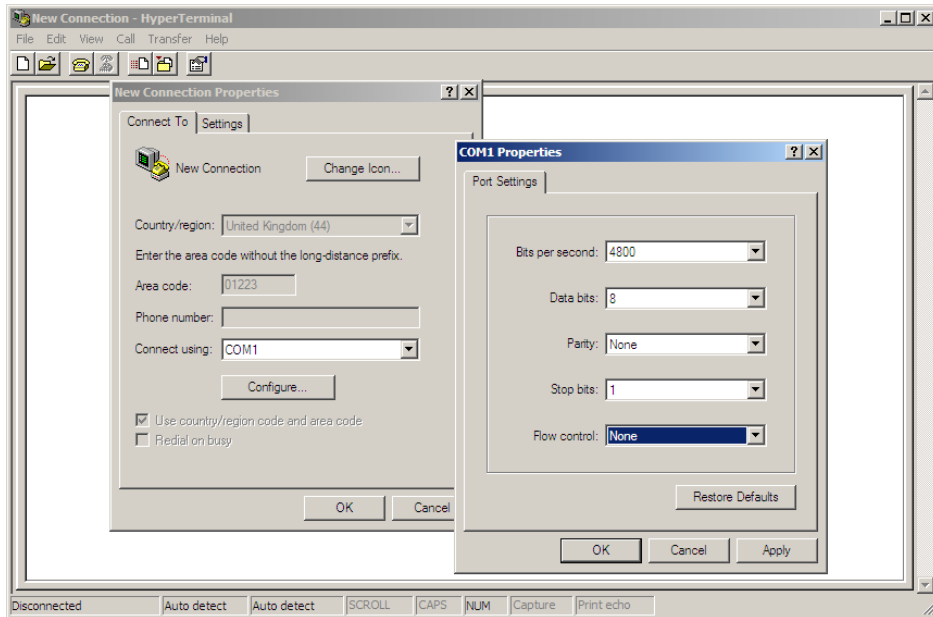

Even if the GPS receiver is receiving no satellite data (for example, if it is being tested inside) then when it is connected to the serial port and a suitable power supply, it should start sending NMEA-0183 sentences similar to those shown below:

```

$GPGSA,A,1,,,,,,,,,,,,,50.0,50.0,50.0*05
$GPRMC,021341.581,V,36000.0000,N,72000.0000,E,,,270102,,*2B
$GPGGA,021342.581,36000.0000,N,72000.0000,E,0,00,50.0,0.0,M,,M,,0000*4C
$GPGSA,A,1,,,,,,,,,,,,,50.0,50.0,50.0*05
$GPRMC,021342.581,V,36000.0000,N,72000.0000,E,,,270102,,*28
$GPGGA,021343.581,36000.0000,N,72000.0000,E,0,00,50.0,0.0,M,,M,,0000*4D
$GPGSA,A,1,,,,,,,,,,,,,50.0,50.0,50.0*05
$GPRMC,021343.581,V,36000.0000,N,72000.0000,E,,,270102,,*29
$GPGGA,021344.581,36000.0000,N,72000.0000,E,0,00,50.0,0.0,M,,M,,0000*4A
$GPGSA,A,1,,,,,,,,,,,,,50.0,50.0,50.0*05

```

The above sentences were recorded when no satellite signals were being received. The first '0' after the 'E' character in the GPGGA sentence indicates invalid fix and the first 'V' character in the GPRMC sentence indicates navigation warning.

If no serial data is received then the GPS receiver is not functioning correctly and so the first course of action should be to either investigate the problem or replace it.

Embedded Information

If the option to embed the GPS data within the video image is selected then the information is seen above the data and time information. The example below shows both position and speed information embedded within the image:



The top line of the embedded information shows the position as longitude followed by latitude in the following format:

DDDMM.MMMMh ddmm.mmmmh

where the fields are:

- DDD*** ***The longitude degrees.***
- MM.MMMM*** ***The longitude minutes (as a decimal)***
- H*** ***The longitude hemisphere ('W' for west of the meridian, 'E' for east of the meridian)***
- dd*** ***The latitude degrees***
- mm.mmmmm*** ***The latitude minutes (as a decimal)***
- h*** ***The latitude hemisphere ('N' for north of the equator, 'S' for south of the equator)***

In the above example, the current coordinates are 0° 11.8464'W, 52° 20.5986'N. Expressed as degrees, minutes, seconds this is 0° 11' 50.784"W, 52° 20' 35.916"N

The line below the position shows the camera name (blank in the above example) followed by the speed displayed in the selected units. The third and final line shows the camera number, the time and the date.

NMEA Sentences

The NMEA-0183 interface standard defines electrical signal requirements, data transmission protocol and time, and specific sentence formats for a 4800 baud serial data bus. Those sentences that are relevant to GPS data and recorded by the *X200 Digital Video Recorder* are detailed below:

GPGLA - Global Positioning System Fix Data

This sentence includes the positioning fix information with additional information about the accuracy of the fix and the satellites used in its determination.

```
$GPGLA,123519,4807.038,N,01131.324,E,1,08,0.9,545.4,M,46.9,M, , *42
```

123519	Fix taken at 12:35:19 UTC
4807.038,N	Latitude 48 deg 07.038' N
01131.324,E	Longitude 11 deg 31.324' E
1	Fix quality: 0 = invalid 1 = GPS fix 2 = DGPS fix
08	Number of satellites being tracked
0.9	Horizontal dilution of position
545.4,M	Altitude, Metres, above mean sea level
46.9,M	Height of geoid (mean sea level) above WGS84 ellipsoid
(empty field)	time in seconds since last DGPS update
(empty field)	DGPS station ID number
*42	Mandatory checksum

GPGLA - GPS DOP and active satellites

This sentence

```
$GPGLA,A,3,04,05,,09,12,,,24,,,,,2.5,1.3,2.1*39
```

A	Auto selection of 2D or 3D fix (M = manual)
3	3D fix
04,05...	PRNs of satellites used for fix (space for 12)
2.5	PDOP (dilution of precision)
1.3	Horizontal dilution of precision (HDOP)
2.1	Vertical dilution of precision (VDOP)
(DOP is an indication of the effect of satellite geometry on the accuracy of the fix.)	
*39	Mandatory checksum

GPRMC - Recommended minimum specific GPS/Transit data

This sentence includes the minimum recommended GPS data and includes the position (latitude and longitude), speed (in knots), date and time.

```
$GPRMC,225446,A,4916.45,N,12311.12,W,000.5,054.7,191194,020.3,E*68
```

225446	Time of fix 22:54:46 UTC
A	Navigation receiver warning A = OK, V = warning
4916.45,N	Latitude 49 deg. 16.45 min North
12311.12,W	Longitude 123 deg. 11.12 min West
000.5	Speed over ground, Knots
054.7	Course Made Good, True
191194	Date of fix 19 November 1994
020.3,E	Magnetic variation 20.3 deg East
*68	Mandatory checksum

Glossary

<i>Almanac Data</i>	<i>Contains information about the location of the GPS satellites and their orbital information at any time.</i>
<i>Ephemeris Data</i>	<i>Contains information about the status of the satellite, current date and time.</i>
<i>GMT</i>	<i>Greenwich Mean Time</i>
<i>GPS</i>	<i>Global Positioning System</i>
<i>GPSr</i>	<i>Global Positioning System Receiver</i>
<i>NMEA</i>	<i>National Marine Electronics Association</i>
<i>UTC</i>	<i>Coordinated Universal Time</i>

The Menu System V1.9.0

The menu system is used to configure the X200 and gives control over recording resolution, camera sequencing, timer settings, alarm triggering and alarm triggered recording. There is also access to monitor options and password functions along with many other parameters.

A menu can contain the following types of entry:

- Sub-menu heading - press the right arrow menu key and the sub-menu is entered.
- Function - press the right arrow menu key and the function is performed (e.g. Reset System).
- Selection - press the left and right menu keys to cycle through the choices.
- Numeric item - input numbers 0 to 9 on the keypad (e.g. entering a time) and use the left arrow button to go back and correct mistakes.

Any changes made to the menu system have immediate effect on the operation of the system. The menu is stored on non-volatile Flash memory inside the X200. To revert to the factory settings run a RESET MENU TO THE FACTORY DEFAULT STATE WITH: ENGLISH LANGUAGE function in the RESET SYSTEM menu.

Help Screens

Every menu and every item within the menu has a separate help screen. Place the cursor against the chosen item and press the HELP key. Where multiple pages of help are available, move from one to the next by pressing the HELP key. Use the MENU EXIT key at any time to leave the help menu.

Menu Navigation

The menu system on the X200 can be accessed by using the X201 Reviewer. Connect the dedicated 8 way (Ethernet style) cable (supplied with X201) to the recorder and consult the instructions for X201 Reviewer.

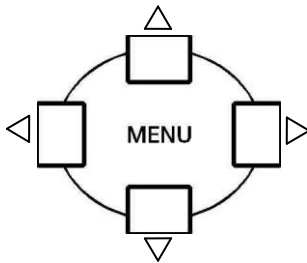

Press any of the 4 menu buttons to enter the main menu. Once in the menu system, their function is as follows:

- △ Move arrow cursor up to the next item.
- ▽ Move arrow cursor down to the next item.
- ◀ If the arrow cursor is currently at a menu selection, (e.g. **RESOLUTION: > HIGH**), pressing the left button will cycle the value backwards, (e.g. to **RESOLUTION: > MEDIUM**),
- ▶ If the arrow cursor is currently at a menu selection (e.g. **RESOLUTION: > LOW**), pressing the right button will cycle the value forwards, (e.g. to **RESOLUTION: > MEDIUM**).

If the arrow cursor is currently at a sub-menu title (e.g. **> OTHER OPTIONS**), pressing the right button will enter this sub-menu.

The **MENU EXIT** key on the X201 Reviewer will exit the current menu and move up 1 level in the menu system when pressed. If already at the top level of the menu pressing this key will exit the menu system completely and return to the video switcher.

If the left and right menu keys have no effect, then numerical entry using keys 0 to 9 is required.

The **SEARCH** key on the X201 Reviewer accesses a menu allowing the user to go to a specific time and date in the recorded footage. Pressing this button will enter the **PLAYBACK SEARCH** screen as seen below. If the footage on a given camera cannot be found (it may not have been recorded), a "**NO FOOTAGE FOR SELECTED CAMERA**" message will be displayed.

PLAYBACK SEARCH

TIME : 00 : 00
DATE : 00 / 00 / 00

PLAY FROM SET TIME DATE

PLAY OLDEST
PLAY NEWEST

TIME – Use the number keys to enter a time in 24hr format.

DATE – Use the number keys to enter a date in the format DD/MM/YY

- **PLAY FROM SET TIME DATE** – Plays the footage beginning from the time and date entered. If there is no footage at the time specified a jump is made to the nearest footage to the time given.

PLAY OLDEST – Plays the oldest available footage on the Hard Disk Cartridge.

PLAY NEWEST – Plays the most recent footage available on the Hard Disk Cartridge.

Main Menu

MAIN MENU	
OTHER	MENU
NORMAL	RECORDING
TIMER	RECORDING
SHOT	RECORDING
AUDIO	RECORDING
MOTION	DETECTION
ALARM	RECORDING
ALARM	INPUTS
ALARM	OUTPUT / LEDs
VIDEO	SWITCHER
VIDEO	SWITCHER 2

Sub-menus available from the MAIN MENU:

OTHER MENU – Leads to the other menu items.

NORMAL RECORDING – Default recording set-up activated by the record on/off button.

TIMER RECORDING – Recording set-up activated by the inbuilt weekly interval timer.

SHOT RECORDING – Shot Recording set-up activated by specified alarm inputs.

AUDIO RECORDING – Set-up for audio recording.

MOTION DETECTION – Set-up for motion detection activation of recording

ALARM RECORDING – Recording set-up activated by the alarm inputs.

ALARM INPUTS – Sets the open/closed conditions and actions for each of the 4 alarm inputs.

ALARM OUTPUTS – Sets the open/closed condition and triggers for the alarm output. Sets the conditions for the external LED outputs.

VIDEO SWITCHER – Sets the dwell times for the main video out.

VIDEO SWITCHER 2 – Sets the dwell times for the switcher video out (X200-16 only).

Other Menu

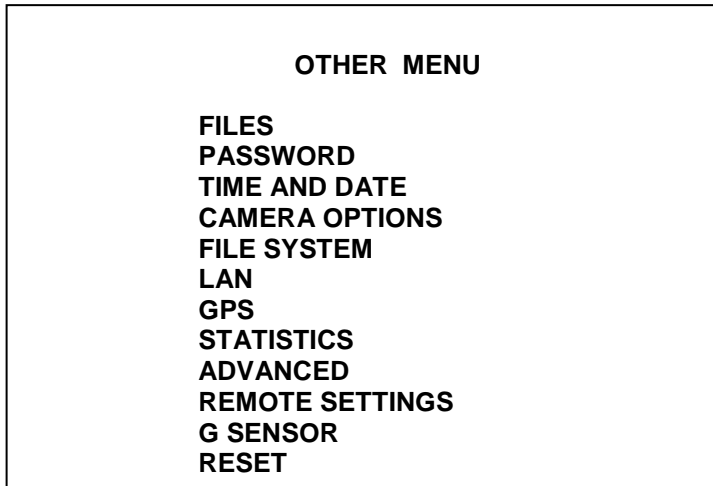

Sub-menus available from the OTHER MENU:

- FILES** – Allows listing and access to all recordings on the Hard Disk Cartridge.
- PASSWORD** – Settings for password protection and change password facility.
- TIME AND DATE** – Change the system time and date plus summertime correction.
- CAMERA OPTIONS** – Settings for camera text and focussing mode
- FILE SYSTEM** – File organisation and health check.
- LAN** – Set-up for LAN connection.
- GPS** – Set-up to confirm connection of GPS device and format of GPS data.
- STATISTICS** – General recoding and system statistics.
- ADVANCED** – Advanced options.
- REMOTE SETTINGS** – Determines the settings for GSM and RS232 control
- G SENSOR** – For future use.
- RESET** – Reset recordings and/or return menu to factory default settings.

Files Menu

FILES		
>FIRST / LAST PAGE		
PAGE	1 OF 1	
W	00:20:00	01/01/04
W A	00:10:00	01/01/04
	00:00:00	01/01/04

The files menu lists the files that are recorded on the Hard Disk Cartridge and allows the user to write-protect or remove write-protection for any file and provides instant jump to any file. The file listing is displayed on a number of pages with each page showing up to 10 files.

- **FIRST / LAST PAGE**

Use the left menu button to view the first page of the file listing. Use the right menu button to view the last page of the file listing.

PAGE

Use the right menu button to advance to the next page of the file listing and the left menu button to move back to the previous page of the file listing. The current page and the total number of pages will be shown by 'x' OF 'x'. For example 1 OF 10 would indicate that page 1 is being shown out of a total of ten pages.

File Listing

The file listing shows files most recent first. Files marked with an 'A' indicate that it is an alarm recording and 'W' indicates that the file is write protected. In the above menu example there are 2 normal recording files and 1 alarm event file which has been write protected. All files are 10 minutes in duration. Also, "M" indicates a motion detection file.

Voluntary Write-Protection

Any file can be write-protected to avoid it being erased on loop recording. For example there may be some critical footage that needs to be kept but the user may want to continue recording on the same disk once he has protected this file. To write protect any file move the arrow cursor next to it in the file listing and press the left menu button, "W" will then appear next to the file showing that it is protected. Write-protection can be removed by pressing the left menu button again. In the above example the file 00:20:00 has been voluntarily write-protected. Pressing the left menu button again removes write-protection (the left menu button toggles the write protect status). Write-protected files appear as write-protected (read only) on the PC. You can change the write-protect status either on the PC or as explained on the X200. Any files that are not write-protected on the X200 get overwritten (oldest first) during the process of recording.

Jump to File

Press the right menu button to jump to the start of the file indicated by the arrow cursor.

Password Menu

PASSWORD	
PASSWORD REQUIRED FOR :	
RECORD:	NO
MENU:	NO
SWITCHER:	NO
PLAY:	NO
>CHANGE PASSWORD ...	

The password menu restricts user access to the four key parts of the system. Here is a summary of the menu selections available:

- **RECORDING** - If set to **YES**, the record button is password protected.
- **MENU** - If set to **YES**, access to the menu system is password protected.
- **SWITCHER** - If set to **YES**, the button to activate auto switcher mode is password protected.
- **PLAY** - If set to **YES**, the controls to review recorded footage are password protected.

If the user tries to access a protected function, he is asked to type in the password. The default password is 0000 when shipped. On correct password entry (four digits e.g. 3524 or 8912) the password protection is temporarily disabled. It is reinstated after 1 minute of no key presses. Protection is also automatically reinstated when leaving the password menu.

- **CHANGE PASSWORD** - The supervisor who knows the password is requested to type in the old password, followed by the new one. He is then requested to retype the new password. If he has done this successfully the new password is made the current one and the password protection is activated.

Hints

It is intended in a password protected system to at least protect the menu system. This ensures that important operating settings cannot be tampered with. Other protection may be required e.g. the record button may be disabled. Some examples are given overleaf.

Examples

Selection	Set to		
RECORDING	YES	YES	NO
MENU	YES	YES	YES
SWITCHER	YES	NO	NO
PLAY	YES	NO	NO
Result:	Full protection - no functions available.	Allow the user to review footage and look at live cameras only.	Allow the user to carry out basic functions, but without access to any menus.

The password for the unit when the unit is shipped is 0000. This may be changed as described previously.

In the event of complete password lockout contact your installer / distributor for a code for the X201 Reviewer. The user can enter a code on the X201 Reviewer which will enable him to reset the unit and reset the password.

Note: playback password cannot be used in conjunction with RS232 playback (RS232 overrides/disables the playback password set on x200).

Time and Date Menu

TIME AND DATE	
TIME:	> 00 : 00 : 00
DATE:	01 / 01 / 04
MODE	DD/MM/YY
SET CLOCK TO THESE SETTINGS ..	
LAN / WLAN TIME ADJUST:	YES
SUMMERTIME ADJUST:	UK
SUMMER / WINTER TIME:	WINTER

The time and date menu sets up the date, time and seasonal correction.

- **TIME** - Type a time using the numbered keys. Invalid times are prohibited
- **DATE** - Type a date using the numbered keys. Invalid dates are prohibited
- **MODE** – Use the left and right menu buttons to toggle the format the date is displayed in between DD/MM/YY and MM/DD/YY.
- **SET THE CLOCK TO THESE SETTINGS** - Press the right menu button to set the time and date as entered above.

You must use leading zeros for the time and date where necessary, e.g. 09:45 and 04/07/98. The unit is shipped from the factory with date and time set to GMT (UCT).

- **LAN / WLAN TIME ADJUST** – If set to **YES** this allows the X200 to accept broadcasts over a LAN/WLAN to adjust its time.
- **SUMMER TIME ADJUST** - Set this to OFF if you do not want the unit to automatically correct for daylight saving time. Select UK / EUR / USA for the unit to automatically adjust for daylight saving time in the UK, Central Europe or USA.

UK - At 1:00 am on the last Sunday in March the clock is put forward 1 hour (summer time)
At 2:00 am on the last Sunday in October the clock is put back 1 hour

EUR - At 2:00 am on the last Sunday in March the clock is put forward 1 hour (summer time)
At 3:00 am on the last Sunday in October the clock is put back 1 hour

USA – At 2:00 am on the second Sunday in March the clock is put forward 1 hour (summer time).
On the first Sunday in November the clock is put back 1 hour.

Summer Time Adjust is automatically applied even if the unit is switched off during the time at which the clocks go forwards or backwards. In the latter case correction is applied on power-up. A message is displayed indicating to the user that the time has been modified.

The Current time period is shown as either **SUMMER** or **WINTER** at the bottom of the menu screen.

Camera Options Menu

CAMERA OPTIONS			
CAM		CAM	
1	C210KHD DOOR	2	C210KHD FRNT
3	C210KHD REAR	4	C210KHD DRVR
5		6	
7		8	
9		10	
11		12	
13		14	
15		16	
DUPLICATE TEXT FROM CAM 1 . .			
TIMESTAMP POS: > BOTTOM LOW			
FOCUS MODE: OFF			

CAMERA TEXT ENTRY - Allows the user to create an optional text label of up to 12 characters per camera.

Use the up and down 'MENU' arrow keys to move to the previous or next camera. Use the numbered keys on the X201 reviewer to cycle through the available characters for that key and the left & right 'MENU' arrow keys to move the highlighted cursor to the previous or next character respectively.

The numbered keys have the following 4 characters attached to them, pressing the key repeatedly will cycle through the 4 available characters. The fifth character on each key is a blank space; use this to delete any unwanted characters.

Key	Number/Characters
1	A B C 1 (blank)
2	D E F 2 (blank)
3	G H I 3 (blank)
4	J K L 4 (blank)
5	M N O 5 (blank)
6	P Q R 6 (blank)
7	S T U 7 (blank)
8	V W X 8 (blank)
9	Y Z 9 (blank)
0	0 (blank)

Keep pressing keys 0 to 9 until the desired character appears. For example pressing key '1' gives the 'A' character, pressing again, the 'B' character, again the 'C' character, again the '1' character and finally a blank character. The sequence repeats. The camera text will appear above the time stamp on each image. Like the time stamp it is embedded into each image and cannot be removed from the image.

DUPLICATE TEXT FROM CAM 1 – Copies the current text from camera 1 to all other cameras. Move the arrow cursor next to this option and press either the left or right menu buttons to copy the text. This avoids repeat typing of vehicle registration numbers or other common text.

TIMESTAMP POS: - The position of the timestamp can be moved to either bottom low/bottom-mid/bottom-high which are 3 positions below the main image or top-low/top-mid/top-high which are 3 positions above the main image. Select **NO TIMESTAMP** if you do not wish to see a timestamp on the recorded images.

A typical time stamp is shown below with camera text:

Camera Text

JKN456Y DOOR

C1 **12:00:00** **27/07/01**

Camera Time Date
Number

The camera number indicates which camera grabbed the image, and the time and date indicate when the image was grabbed.

FOCUS MODE – When set to **ON** the X200 is able to provide an indication of camera focus for each of the connected cameras.

In order to commence camera focusing first stop the X200 recording if it is already doing so. When **FOCUS MODE** is set to **ON** the X200 will start recording image data in order to provide an indication of focus level, this data is not recorded to the Hard Disk Cartridge. When the process is finished select **OFF** to stop the X200 recording data for camera focusing and recommence recording as required.

The indication of camera focus can be provided by either one of the LED outputs or a suitable buzzer/LED circuit connected to the X200 Alarm Output providing a positive confirmation when the Alarm Output is active.

In order for the X200 Alarm Output to activate a buzzer/LED for camera focusing It is necessary for the **CAMERA FOCUSING** option to be set to **YES** in the Alarm Output / LED's menu if the alarm output is to be used. If one of the LED outputs is to be used then either **LED1 OUTPUT** or **LED2 OUTPUT** will need to be set to **FOCUS** and a suitable circuit connected to the relevant LED output.

To focus a camera when in **FOCUS MODE** and with a suitable indicator circuit attached to the X200 Alarm Output or one of the LED outputs, first cover the lens of the camera in question for a couple of seconds. A long indication will be given from the attached buzzer/LED to indicate that the camera has been selected.

Whilst adjusting the focus of the selected camera the presence of short buzzes/lights indicates that the focus is improving. If the camera focus overshoots and begins to worsen the buzzes/lights will stop. To bring the camera back into focus move the focus in the opposite direction until a short duration indication is given again. The optimum focus will be found between these two points.

In order to switch to another camera cover the camera lens of the camera in question for a couple of seconds until a long duration buzz/light is shown. This camera is now selected and the focusing process can be completed as previously described.

File System Menu

FILE	SYSTEM
RECORDING MODE : >LOOP RECORD	
FILE LENGTH :	10 MINUTES
FILENAME TEXT :	
WRITE PROTECT ALARM REC :	NO
WRITE PROTECT SHOT REC :	NO
FILE SYSTEM CHECK MENU . .	

The file system menu controls how files are laid onto the disk.

- **RECORDING MODE-** Sets either **LOOP RECORD** (oldest files will be overwritten first when Hard Disk Cartridge is full) or **SINGLE PASS** recording (recording will stop when Hard Disk Cartridge is full).
- **FILE LENGTH – 10 MINUTES / 1 HOUR / UNLIMITED**
This controls how often new files are created, set the file length as appropriate. The 1 hour setting is useful if you are recording over a long period of time and it is desirable to have a smaller number of files to manage or archive. The 10 minute setting gives more files but each is of a small size and this may help in searching for specific short duration events. Unlimited will produce a file each time the X200 is powered-up and recording is started. The X200 will continue to record a single file until it reaches 2GB, then a new file will be started. Note that UNLIMITED cannot be used with NTSC recording format.
- **FILENAME TEXT –** Enter up to 12 characters of text that will appear at the start of all files. For mobile applications a vehicle registration number could be used. The X200 serial number could also be used.

This improves the audit trail. Please note that the filename and serial number are buried into each file for audit trail purposes and can be verified.

- **WRITE PROTECT ALARM REC –** Select whether alarm recording files are write protected. If alarm recording files are write protected they will not be deleted on loop recording (LOOP RECORD setting).

To remove write-protection either use the files menu and the left menu button (toggle 'W' status) or delete all recordings via the reset menu.

- **WRITE PROTECT SHOT REC –** Select whether shot recordings are write protected. This is the same as per the **WRITE PROTECT ALARM REC** function but only affects shot recording files.

FILE SYSTEM CHECK MENU – Accesses the file system check menu.

File System Check

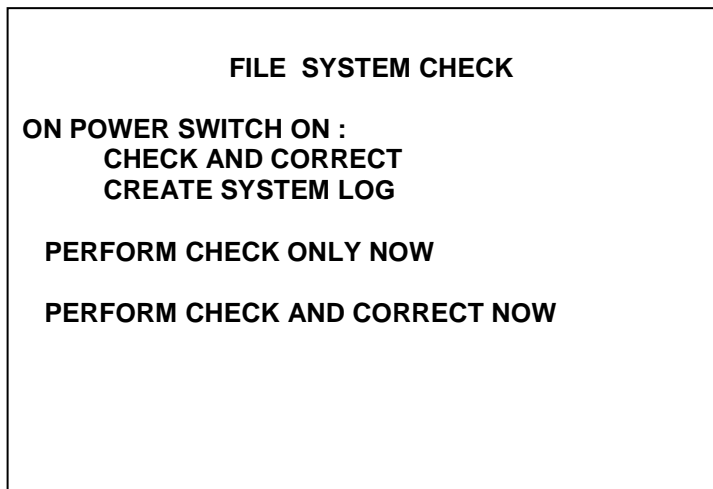

This menu sets the default file checking and correcting action on switch on and can be used to check and/or correct files manually at any time.

NO CHECK / CHECK ONLY / CHECK AND CORRECT – Gives the option to check the file system at power on and optionally correct any errors. This is the recommended option as the X200 will check and correct both the file system and FAT of the Hard Disk Cartridge on start-up.

CREATE SYSTEM LOG / DO NOT CREATE SYSTEM LOG – Determines whether a system log file is created and copied to the Hard Disk Cartridge when the X200 is powered-up. This file can be used by Timespace Technology as a diagnostic file to check system performance. It is highly recommended that the default option of CREATE SYSTEM LOG is used.

PERFORM CHECK ONLY NOW – Pressing the right menu button will perform a file system check.

PERFORM CHECK AND CORRECT NOW – Pressing the right menu button will perform a file system check and fix any errors that are found.

LAN Menu

```

                                LAN

LAN STATUS : DISCONNECTED
IP ADDRESS : > 10.  0.   0 . 200
SUBNET MASK :   255 . 255 . 255 .   0
GATEWAY :      10.  0.   0 . 255

PING TEST . . .

RECORD DURING TRANSFER:  NO
LAN IDLE TIMEOUT:       1 MIN
TIME ADJUST PORT:       8463
MAC :                   00 : 0F : B4 : 00 : 00 : 00

```

- **LAN STATUS** – Indicates whether the X200 is currently connected to a LAN enabled device.

IP ADDRESS – For devices communicating on a network, messages must identify the source and destination with an address. The IP (internet protocol) address is a 32-bit number that uniquely identifies a device connected to the network and is usually represented in a dotted decimal form.

e.g. 10.0.0.28

Use the right and left menu arrow keys to move across the input fields and the number keys to input the address.

SUBNET MASK – The subnet mask is used to determine what subnet an IP address belongs to. An IP address has two components, the network address and the host address. Subnetting enables a network administrator to further divide the host part of the address into two or more subnets. In this case, a part of the host address is reserved to identify the particular subnet.

The subnet mask is the network address plus the bits reserved for identifying the subnetwork. (By convention, the bits for the network address are all set to 1.) As a mask, it can be used to identify the subnet to which an IP address belongs by performing a bitwise AND operation the mask and the IP address. The result is the subnetwork address.

Use the right and left menu arrow keys to move across the input fields and the number keys to input the address.

GATEWAY – This is the address of the 'gateway' in a network that a computer will use to access another network if a gateway is not specified for use. In a network using subnets, it is the address of the router that forwards data traffic to a destination outside of the subnet of the transmitting device.

Use the right and left menu arrow keys to move across the input fields and the number keys to input the address.

PING TEST ... – Selecting this option by pressing the right menu button will bring up the 'ping test' menu which is shown below.

```

PING TEST

PING ADDRESS: 10. 0. 0. 1

>DO PING TEST      REPLY RECEIVED

BYTES SENT:       3988
BYTES RECEIVED:  5304

```

Enter the destination IP address of the unit you want to test communication with on the ping address line by using the left and right menu buttons to move across the fields and the number keys and then select DO PING TEST If the destination receives the ping message and replies within 10 seconds then REPLY RECEIVED is displayed; otherwise 'NO REPLY' is displayed.

The BYTES SENT and BYTES RECEIVED fields update in real-time to show how many bytes are being transferred to and from the X200 and can provide further indication of data transfer.

- **RECORD DURING TRANSFER** – If set to **NO** then the X200 will stop recording whilst LAN file transfer is taking place. If set to **YES** then the X200 will continue to record whilst LAN file transfer is taking place, but this will have a negative impact on the transfer speed.
- **LAN IDLE TIMEOUT** – If the alarm output is being used to indicate LAN activity then the LAN idle timeout will set the amount of time until the alarm output deactivates after no LAN activity.
- **TIME ADJUST PORT** – The port number used by LANLink in order to check and synchronise the X200 internal clock to the LANLink reference.

MAC – All network devices include a unique media access control (MAC) address used to identify it on a network. The address is a 48 bit number, usually represented as 6 bytes – each byte written in hexadecimal notation.

All Timespace Technology devices have a MAC address which begins 00 0F B4 followed by another three bytes.

e.g. 00 0F B4 00 0A 48

The X200 LAN menu option allows the user to display its MAC address which may be useful in configuring access control with wireless networks.

GPS Menu

GPS	
EMBED GPS POSITION :	NO
EMBED GPS SPEED :	NO
SPEED UNITS :	MPH
SYNC CLOCK WITH GPS :	NO
GPS BAUD RATE:	4800 bps
GPS NOT CONNECTED	

Embed GPS Position – Selecting YES will cause the position information to be embedded in the recorded image.

Embed GPS Speed – Selecting YES will cause the speed information to be embedded in the recorded image.

Speed Units – Select either KPH for kilometres per hour or MPH for miles per hour.

Sync Clock with GPS – The X200 Digital Recorder includes a clock which is used to timestamp recording files and overlay the date and time on recorded images. Although accurate, the system can be configured to synchronize the clock with the date and time information received from the GPS receiver.

Synchronization only occurs when the X200 is powered up and before it starts recording. At this time the built-in clock may be corrected by a maximum of 20 seconds if a previous discrepancy has been detected between the internal time and the GPS receiver time.

Selecting YES will synchronize the X200 clock on power up. The time received from the GPS receiver is always UTC (Coordinated Universal Time) which is the same as GMT (Greenwich Mean Time).

The current status of the attached GPS device (mouse) is show at the bottom of the screen which indicates whether it is connected and able to lock to the GPS satellites.

GPS Baud Rate - Set the X200 data rate according to the GPS mouse you are using. Rates configurable include; 2400, 4800, 9600 and 19200, 38400 bps.

Statistics Menu

STATISTICS	
	OPERATING SYSTEM: 1.7.0
160.0	SIZE IN GIGABYTES
50%	USED
20%	WRITE PROTECTED
342	FILES
01 / 10 / 07	START DATE
21 / 10 / 07	END DATE
21.0	DAYS RECORDING
VIEW SERVICE LOG	
FAIL QUOTA/DAY: 10/DAY	

The statistics page gives the operating system version number, disk size, percentage used and percentage write protected.

Recording statistics are updated every minute and are intended to be used for monitoring a camera system and to provide an indication of the capacity of the X200 in different recording environments.

The total number of files along with the start date, end date and total amount of days recording are shown.

The Service log cant be viewed from here and holds specific information about service events. It can also be reset from within the view service log sub menu.

Set how many fail messages that must occur for any given day before the FAIL LED is lit.

Advanced Menu

```

                                ADVANCED

> USE RECORD STATE AT POWER OFF
  ENABLE X200 RECORD BUTTON: YES

LOAD SYSTEM UPGRADE . .
SAVE SYSTEM UPGRADE . .
LIVE VIEW:      OFF
HEALTH PAGE DISPLAY:    OFF
SPLASH SCREEN:    OFF
RECORDING SETTINGS
MODEM LOOPBACK TEST

H/W VER: 16AE      SERIAL NUMBER: 42
```

The advanced menu provides control over more sophisticated X200 functions.

The default setting **USE RECORD STATE AT POWER OFF** means that if the unit was recording when it was switched off it will record when it is switched back on. Also if the unit wasn't recording when it was switched off it won't be recording when it is switched on. This setting is generally convenient for covert use where recording is switched on and off by pressing the record button and the unit continues the way it left off. Also convenient if you want the X200 to continue recording after a power cut.

The **DO NOT RECORD AT POWER UP** setting is useful if manual adjustments need to be made to the menu settings every time the unit is switched on prior to recording. Note that the unit will not do normal recording after a loss of power e.g. in a power cut so this setting should be used with caution.

The **RECORD AT POWER UP** setting should be used if the unit is always to do normal recording on power up. This is important in vehicle applications where the user may have inadvertently switched the unit off in a non-recording state (e.g. he has just been playing back some footage and he switched off recording to make this easier). With this setting however the unit is left at switch off, it will record the next time it is powered up.

ENABLE X200 RECORD BUTTON – If set to YES the 'Record' button on the front of the X200 will switch Normal Recording on and off. If set to NO this button is disabled.

LOAD SYSTEM UPGRADE – This loads a new version of the X200 operating system from the Hard Disk Cartridge. See "Software Updates" page for detailed instructions.

SAVE SYSTEM UPGRADE – This saves the X200 operating system and current menu settings to the Hard Disk Cartridge as a .xos file. The Cartridge can then be used as a master to set up another X200 with the same software version and menu settings. Use LOAD SYSTEM UPGRADE on the other X200 with the master Cartridge inserted.

LIVE VIEW – When set to ALWAYS the X200 video outputs will show the live views from connected cameras as determined by the Video Switcher Menus even if a Hard Disk Cartridge is not installed. If set to OFF the video outputs will not show the live camera views and the Main Output will show an error message stating the no Hard Disk Cartridge has been installed in the recorder.

HEALTH PAGE DISPLAY – Set the length of time for which the health page is displayed at startup. This includes information such as - Last recording time, Current Time, Working Cameras, System Status.

Example HEALTH PAGE DISPLAY

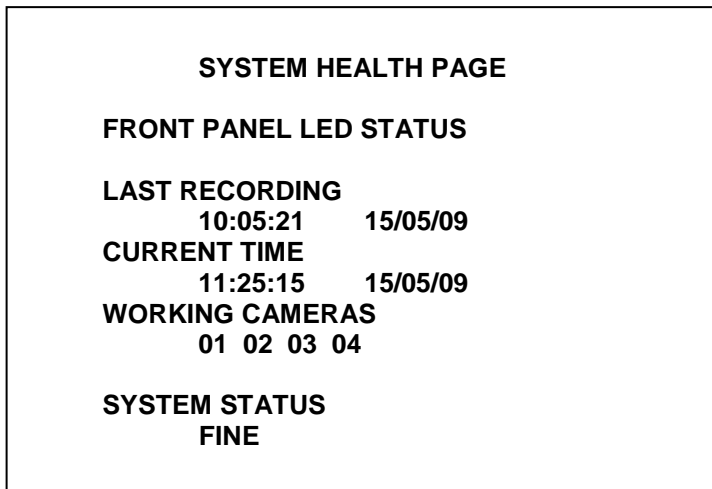

SPLASH SCREEN – Enable's use of a .BMP file to be displayed, for example an Operator/Company logo. Can be set to 5, 10, 20, 30, 60 seconds, or Until Exit (which requires user interaction to clear).

A tool can be provided on request to create the Splash Screen image in the correct format, from an input source. The input source should not be more than 1.5mb and should be a simple image with plain colours, approx 720x576. An example images is show below;

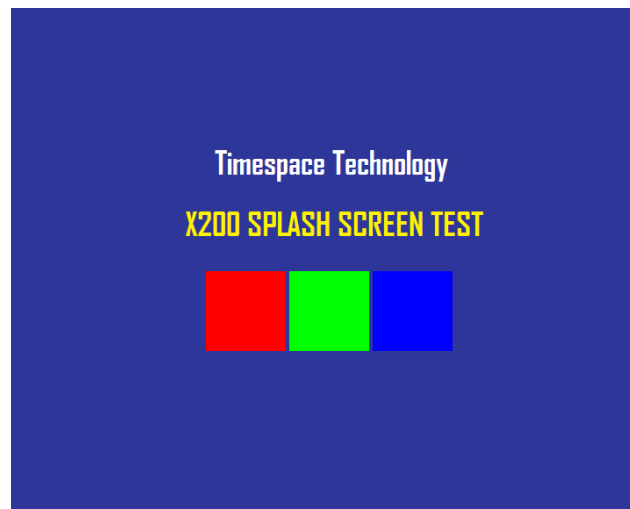

Once in the correct format (using the Timespace conversion tool), the image is placed on the X200 cartridge, named; **Splash.ext**. Once configured in the menu, the Splash Screen will be read from the disk and displayed.

RECORDING SETTINGS – Accesses a sub-menu allowing control over recording mode, video standard and multiple/single camera optimisation.

MODEM LOOPBACK TEST - The modem loopback test checks that the internal X200 hardware is functioning correctly so that it can be successfully used with an external modem. A special female 9-way D socket is required with pins 2 & 3 connected together and pins 1, 7 & 8 connected together. This is connected to the male RS232 socket on the rear panel of the X200 before conducting the modem loopback test. The RS232 connector is detailed in the Connector Specifications section of the X200 manual. To start the test press the right menu button. If PASS is shown on the menu screen next to the MODEM LOOPBACK TEST then the internal hardware is functioning correctly. The hardware version (H/W VER) and serial number of the X200 are also shown at the bottom of the menu screen for reference.

Recording Settings Menu

RECORDING SETTINGS	
RECORDING MODE FOR:	
NORM / TIMER:	COND. REFRESH
ALARM / SHOT:	FULL UPDATE
VIDEO STANDARD:	PAL
COLOUR DISCRIMINATION:	AUTO

The Recording Settings sub-menu allows the user to choose between single/multiple camera optimisation, recording modes and video standards.

RECORDING MODE FOR:

NORM / TIMER :
ALARM / SHOT :

COND. REFRESH / FULL UPDATE – The recording mode is selectable for normal and timer recording and also for alarm and shot recording.

Specify **FULL UPDATE** to record full image information or **CONDITIONAL REFRESH** to record only the parts of the image that have changed.

In most cases conditional refresh will be the preferred option as the file size on disk is reduced from that required for full update.

VIDEO STANDARD

PAL / NTSC – After moving the cursor down the Video Standard line, the user can use the cursor keys to select between PAL and NTSC. Once the appropriate selection has been made the unit must be power-cycled before it comes into effect. During the power up sequence, the X200 will briefly display the software version installed along with the configured video standard.

Please refer to the PAL / NTSC Switching section of this manual for further information about using the X200 in PAL and NTSC configurations.

- **COLOUR DISCRIMINATION** – The default setting of **AUTO** should normally be used. The YES and NO settings may be used in particular cases if images from colour/B&W switching cameras need to have false colour images rejected.

Remote Settings Menu

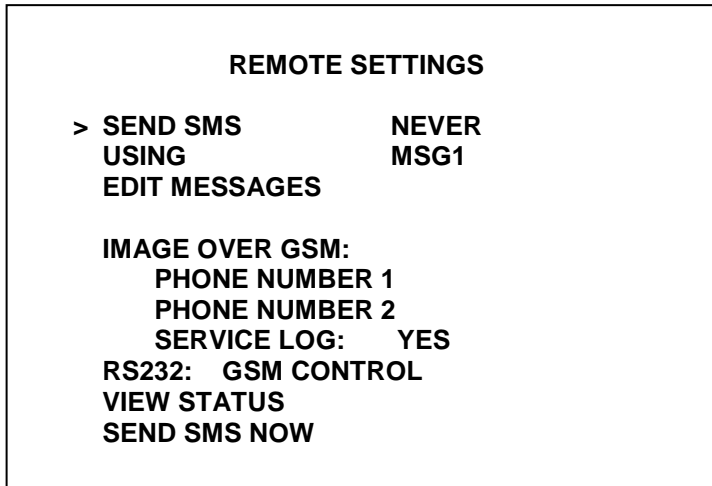

- **SEND SMS: NEVER / MONTHLY / WEEKLY / DAILY / POWER UP** – Determines how often the X200 will send the user defined SMS text message. It is possible to select once per month, week, day or every time the X200 is power-cycled.
- **USING** - Selects which SMS message will be sent as determined in the SEND SMS option.
- **EDIT MESSAGES** - Enters the SMS MESSAGES sub-menu allowing the user to enter in up to 6 different SMS text messages.
- **IMAGE OVER GSM** – Feature for transmitting an image from **Camera1** to a PC (running ImageLink) using a GSM modem. Enter the mobile number to send Images over GSM (setup as an **Alarm Input**). A secondary number can be entered if the primary is engaged. A retry mechanism will dial number1, number2, number1, number2, with approximately 40 seconds between each retry. Number1 & Number2 can be the same number if required. By default if the transmission fails, the Service light will be illuminated and a Service log entry made (this can be turned off). See Alarm Input and LED output pages for detail. **ImageLink** PC application is included with PCLink Suite. See PCLink section for more details.
- **RS232** - When set to GSM CONTROL the RS232 serial port on the rear of the X200 can be connected to a suitable GSM modem and used in conjunction with RemoteLink PC software in order to remotely control the X200 recorder. For further information on this please consult the GSM subsection of the Remote Operation section of this manual.

The X200 recorder is also able to be externally controlled via the RS232 interface from 3rd party systems. If this is the case then the appropriate **Baud Rate** for interfacing with the 3rd party system should be chosen. For detailed application information on using the RS232 port to control the X200 and allow data transfer to and from a 3rd party system please refer to RS232 External Control sub-section of the Remote Operation section of this manual.

Please note that if this option is used and the **GSM CONTROL** option is not selected, then the X200 cannot to be used with a GSM modem and RemoteLink PC software. A GPS receiver cannot be connected to the X200 when external RS232 control is utilised as this device makes use of the same port and is not able to run concurrently.

- **VIEW STATUS** - Enters the SMS STATUS sub-menu allowing the user to view statistics on the attached GSM modem.
- **SEND SMS NOW** - Tests the GSM/SMS connection by sending a user defined message to the phone number entered into the **SMS MESSAGES** sub-menu.

SMS Messages Menu

SMS MESSAGES	
MESSAGE	MSG1
PHONE NUMBER	
MSG LINE 1	
MSG LINE 2	
MSG LINE 3	
MSG LINE 4	
EMBED GPS LOCATION	NO
EMBED GPS SPEED	NO

The SMS Messages sub-menu allows the user to specify the phone number for the SMS text message to be sent to and the contents of the SMS text messages.

- **MESSAGE**

Chooses between the 6 different available SMS text messages.

- **PHONE NUMBER**

The number keys on the Reviewer are used to enter the phone number to which the SMS text message will be sent. Do not leave any spaces in the phone number.

- **MSG LINE 1 / 2 / 3 / 4**

The text to be sent is entered using the number keys 1-9 on the Reviewer; up to four lines of text can be entered. Use the left and right menu buttons to move to the previous or next character on each line respectively. Use the up and down menu buttons to move to the previous or next line of text respectively.

Key	Number/Characters
1	A B C 1 (space)
2	D E F 2 (space)
3	G H I 3 (space)
4	J K L 4 (space)
5	M N O 5 (space)
6	P Q R 6 (space)
7	S T U 7 (space)
8	V W X 8 (space)
9	Y Z 9 (space)
0	0 (space)

- **EMBED GPS LOCATION / SPEED**

Allows the current GPS location and speed to be sent as part of the SMS text message if a GPS receiver is used with the X200.

SMS Status Menu

SMS STATUS		
LAST SMS SENT	:	UNKNOWN
MODEM NOT AVAILABLE		
CALLS RECV	000	
SMS RECV	000	
SMS SENT	000	
SMS ERRORS	000	
RESET MODEM		

The SMS Status sub-menu provides information about a connected GSM modem.

- **LAST SMS SENT**

The date of the last SMS sent from the X200.

- **MODEM IN AUTOANSWER MODE / MODEM NOT AVAILABLE**

Shows whether a GSM Modem is attached and setup correctly in autoanswer mode.

- **CALLS RECV**

The number of calls received by the GSM Modem attached to the X200.

- **SMS RECV**

The number of SMS text messages received by the X200.

- **SMS SENT**

The number of SMS text messages sent by the X200.

- **SMS ERRORS**

The number of failures to send an SMS text message at the user defined intervals.

- **RESET MODEM**

Resends the setup commands to reset a connected GSM Modem.

G Sensor (Accelerometer)

G SENSOR			
BRAKE	G	ACC	G
		LAT	G
UP	G		
GSENSOR SETUP		RESET ALARM	RESET READINGS

RESET READINGS - Clears all current readings within this hour.

RESET ALARM – Clears the alarm condition.

GSENSOR SETUP – Enters the GSensor Setup sub menu.

All captured data cant be reviewed and filtered using Timespace Technology's SafteyLink pc application, in conjunction with LANLink (see the SafetyLink section of the manual for further details).

BRAKE is the measurement of decreasing forward motion.

ACC is the measurement of increasing forward motion.

LAT is the measurement of lateral movement.

UP is the measurement of upwards motion.

All measurements are in terms of G.

G Sensor Setup (Accelerometer)

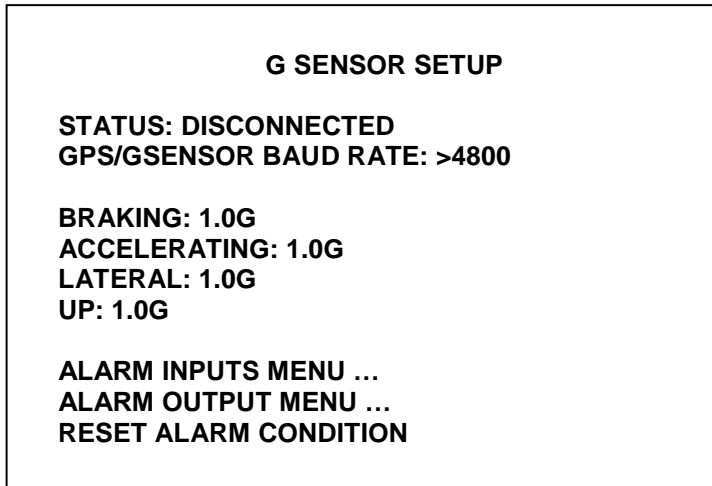

BAUD RATE – The GSensor requires 19200bps and if a GPS is connected as well it must be able to support and be programmed to operate at 19200 as well, for example the Garmin GPS16 LVS.

THRESHOLD TRIGGERS – Braking, Accelerating, Lateral and UP. Can be set from 0.1 – 2.0.

ALARM INPUTS MENU – An alarm input can be configured to reset the GSensor alarm.

ALARM OUTPUT MENU – An alarm output can be configured based on the GSensor thresholds.

RESET ALARM – Clears the alarm condition.

Reset System Menu

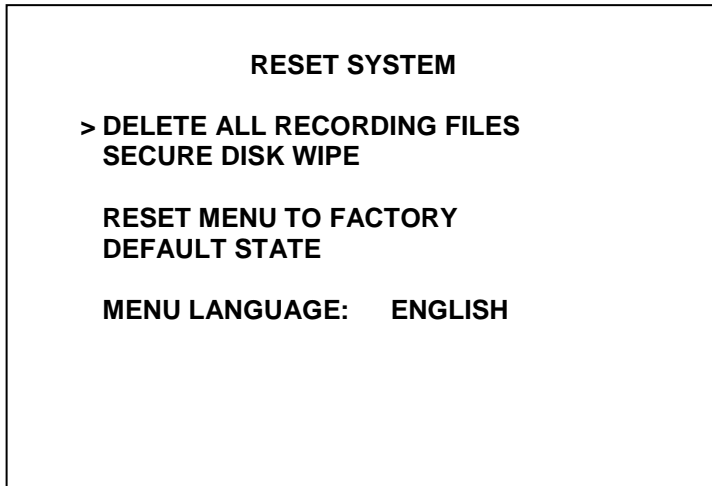

- **DELETE ALL RECORDING FILES** – Removes all recordings from the hard disk including write-protected files. Only do this if you want to completely remove all recordings from the hard drive as there is no undo option. Press the right menu button to go to a warning screen, pressing the right menu button again will carry out this action whilst pressing the MENU EXIT button will abort this procedure.
- **SECURE DISK WIPE** – Permanently deletes all recordings on the Hard Disk Cartridge. This option should only be used if all recording files should be completely destroyed as no files will be able to be recovered.
- **RESET MENU TO FACTORY DEFAULT STATE** – Pressing the right or left menu button will immediately reset the entire X200 menu system to its default settings. Please note that there is no undo option.
- **MENU LANGUAGE** – Sets the language that the menu is displayed in.

Timespace Technology can provide a language template file which the user can translate and return to Timespace Technology for incorporation into the X200 software. This will allow all text displayed on the X201 Reviewer to be in the users preferred language.

When another language is selected in the Reset System Menu the X200 will have to be power cycled before the new language settings will take effect.

Normal Recording Menu

NORMAL RECORDING									
CAMERAS		IMAGES / SEC				RESOLUTION			
1 TO 4	> 5					HIGH			
2 TO 16	NO RECORDING					LOW			
AUDIO: OFF									
RECORD ALL SPECIFIED CAMERAS									
COL	B&W	01	02	03	04	05	06	07	08
		09	10	11	12	13	14	15	16
20 IMAGES / SEC OUT OF 25 MAX									

This menu sets the images per second and image resolution recorded by each camera during normal recording.

CAMERAS – Use the up and down menu buttons to move between items in the menu. Pressing the right and left menu buttons next to a camera group will increase or decrease the number of cameras in that group respectively.

Please note that this applies to the X200-16. The X200-04 lists each of the 4 cameras separately.

IMAGES / SEC - NO RECORDING / 0.1 / 0.2 / 0.3 / 0.4 / 0.5 / 0.6 / 0.7 / 0.8 / 0.9 / 1.0 / 1.2 / 1.5 / 2.0 / 2.5 / 3.0 / 4.0 / 5.0 / 6.0 / 7.0 / 8.0 / 9.0 / 10 / 12 / 15 / 20 / 25 / MAX RATE-

This sets the number of images per second to be recorded by a camera during normal recording up to a total of 25 images per second for all cameras added together. If MAX RATE is selected then the X200 will automatically adjust the images per second for each of the specified cameras so that the total is equal to 25 images per second.

RESOLUTION – This can be set to:

LOW – This sets the highest level of compression. Although file sizes will be comparatively small, visible blocking artefacts may be seen.

MEDIUM – This sets the medium compression level, images with little loss of quality which will be adequate for most applications.

HIGH – This sets a medium-low level of compression with gains in image quality over medium resolution but with larger file sizes.

V.HIGH – This sets a low level of compression with gains in image quality over high resolution but with larger file sizes.

VV.HIGH – This sets the lowest level of compression with the best image quality but the largest file sizes.

AUDIO – Specifies whether audio is enabled (ON) or disabled (OFF) for this mode of recording.

RECORD ALL SPECIFIED CAMERAS
ONLY RECORD CONNECTED CAMERAS

This sets whether the X200 will record on all cameras specified in the recording parameters shown at the top of the menu screen or whether the X200 will only record on connected cameras shown as highlighted on the connected camera list 01 – 16 at the bottom of the menu screen (01 – 04 on the X200-04).

COL B&W 01 02 03 04 05 06 07 08 09 10 11 12 13 14 15 16 - The connected camera list highlights all connected cameras in either red or white to indicate that either a colour (red highlight) or black and white (white highlight) camera is connected to the corresponding input number.

X IMAGES / SEC OUT OF 25 MAX – This displays how many images per second will be recorded during normal recording out of the X200 25 images per second maximum limit. Although less than 25 images per second can be recorded, the X200 is not able to record more than 25 images per second.

If the maximum of 25 images per second is exceeded by the sum of all the cameras then the **X IMAGES / SEC OUT OF 25 MAX** text will change to red as a warning. If this is not corrected then the X200 will still record but it will automatically adjust the images per second for each camera so that the total does not exceed 25.

In the example menu screen shown above cameras 1 – 4 have been set to 5 images per second. This gives a total sum of 20 images per second out of the available 25.

Timer Recording Menu

TIMER RECORDING		
CAMERAS	IMAGES / SEC	RESOLUTION
1 TO 4	>5	HIGH
2 TO 16	NO RECORDING	LOW
START / STOP TIMES . . .		AUDIO: OFF
WHEN TIMER STOPS :		STOP REC.
20 IMAGES / SEC OUT OF 25 MAX		

This menu sets the images per second and image resolution recorded by each camera during timer recording. Preference for times of recording and dates to be excluded can also be set in the 'timer recording times' sub-menu accessible from this menu.

Use the up and down menu buttons to move between images per second and resolution for each camera and the left and right menu buttons to scroll between the options. Pressing the right menu button next to SET TIMER START / STOP TIMES accesses the timer recording times sub-menu.

CAMERAS – Use the up and down menu buttons to move between items in the menu. Pressing the right and left menu buttons next to a camera group will increase or decrease the number of cameras in that group respectively.

Please note that this applies to the X200-16. The X200-04 lists each of the 4 cameras separately.

IMAGES / SEC – These settings are the same as described in the normal recording menu, except they apply only during timer recording.

RESOLUTION – These settings are the same as described in the normal recording menu, except they apply only during timer recording.

SET TIMER START / STOP TIMES - Pressing the right menu button nest accesses the timer recording times sub-menu described on the next page.

AUDIO – Specifies whether audio is enabled (ON) or disabled (OFF) for this mode of recording.

WHEN TIMER STOPS – Pressing the left or right menu buttons chooses between STOP REC. and NORMAL REC. This option decides whether the X200 will stop recording when the defined timer recording period has ended (STOP REC.) or whether it will continue recording in normal recording mode (NORMAL REC.).

X IMAGES / SEC OUT OF 25 MAX – This displays how many images per second will be recorded during timer recording out of the X200 25 images per second maximum limit. This display is the same as found in the normal recording menu, except it applies only during timer recording.

Timer Recording Times Menu

TIMER RECORDING TIMES				
> IGNORE DAILY TIMES				
MON	08:15	TO	17:00	COPY
TUE	08:15	TO	17:00	DOWN
WED	08:15	TO	17:00	
THU	08:15	TO	17:00	
FRI	08:15	TO	17:00	
SAT	00:00	TO	00:00	
SUN	00:00	TO	00:00	
IGNORE PERIOD TIMES				
FROM	:00:00		00 / 00 / 00	
TO :	00:00		00 / 00 / 00	

The timer recording times menu sets the times that will be included or excluded for timer recording. A period of exemption/inclusion can also be set by date. This menu is a sub-menu of the timer recording menu and is accessed by pressing the right menu button next to the SET TIMER START / STOP TIMES option in the timer recording menu.

- **IGNORE DAILY TIMES**
RECORD BETWEEN DAILY TIMES
RECORD OUTSIDE DAILY TIMES

Use the right and left menu buttons to scroll between the available options. The default setting IGNORE DAILY TIMES disables timer recording, the setting RECORD BETWEEN DAILY TIMES will mean that timer recording will automatically take place between the start (left hand time column) and end times (right hand time column). The setting RECORD OUTSIDE DAILY TIMES does exactly the opposite with timer recording automatically taking place outside of the specified times.

Setting the daily times and using the COPY DOWN function.

Use the up and down menu buttons to move the arrow cursor up and down the list of start and end times for each day. When the cursor is next to a particular start / end time use the numbered keys on the X201 reviewer to enter a time in 24hr clock format. Please note that 4 digits must always be entered so single digit hour times such as 8am must be entered as 08:00 as per the normal 24hr clock. To exclude any particular day from timer recording simply type in 00:00 for both times as per SAT and SUN in the example above.

The **COPY DOWN** function allows the current times set for MON to be copied to all other days on the list. This avoids unnecessary repetition when entering timing periods where daily recording times are the same. Once the times for MON have been copied to all other days they may be individually changed as per normal. For instance in the above example the times for MON - 08:15 TO 17:00 – were copied to all other days using the COPY DOWN function and then SAT and SUN were individually set to 00:00 to exclude them from timer recording.

- **IGNORE PERIOD TIMES**
RECORD INSIDE PERIOD
RECORD OUTSIDE PERIOD

This enables the user to set a period of time, by time and date which is to be excluded/included from the daily timer recording parameters. Use the menu up and down buttons to move between the times and dates and enter the time or date using the number keys. The time is in 24hr clock format and the date is in the format DD/MM/YY.

Examples of Timer Recording

The daily times and period times are able to work together or independently to record as and when required. For example -

Recording Monday to Friday from 9am to 5pm.

Select RECORD BETWEEN DAILY TIMES and set the daily times on Monday to Friday from 09:00 TO 17:00 and Saturday and Sunday to 00:00 TO 00:00. Select IGNORE PERIOD TIMES to disable the calendar period function.

Recording Monday to Friday from 9am to 5pm but not in the month of June in 2004.

Select RECORD BETWEEN DAILY TIMES and set the daily times on Monday to Friday from 09:00 TO 17:00 and Saturday and Sunday to 00:00 TO 00:00. Select RECORD OUTSIDE PERIOD in the calendar period function and set the FROM and TO as 00:00 01/06/04 and 00:00 30/06/04 respectively. This will prevent recording from midnight on the first of June to midnight on the 30th of June 2004.

Recording continuously for 3 weeks starting at 7am on the 21st of August 2004.

Select IGNORE DAILY TIMES to disable the daily recording times (this is necessary as recording is to take place for 24hours a day during the calendar period). Select RECORD INSIDE PERIOD and set the FROM and TO as 07:00 21/08/04 and 07:00 11/09/04 respectively.

Shot Recording Menu

SHOT RECORDING	
CAMERAS :	> ALARM IN MENU
RESOLUTION :	LOW
NUMBER OF SHOTS :	1
IMAGES / SEC :	1.0

Shot recording allows a defined number of shots (images) to be recorded from an alarm input trigger.

- **CAMERAS** – This takes the user to the alarm inputs menu in which they can which alarm inputs will be used as a trigger for shot recording and from which cameras to record images. Please see the section on the alarm inputs menu for a detailed description of the available settings.

RESOLUTION - These settings are the same as described in the normal recording menu, except they apply only during shot recording.

NUMBER OF SHOTS

1 / 2 / 3 / 4 / 5 / 8 / 10 / 15 / 20 / 25 / 30 / 50 / 100 / 150 / 250 / 500 – This sets the number of shots to be taken from each camera during shot recording. Use the left and right menu buttons to scroll from between 1 to 500 shots.

- **IMAGES / SEC** – These settings are the same as described in the normal recording menu, except they apply only during shot recording.

Audio Recording Menu

AUDIO RECORDING	
AUDIO WITH NORMAL RECORD: OFF	
AUDIO WITH TIMER RECORD: OFF	
AUDIO WITH ALARM RECORD: OFF	
CHANNELS:	> STEREO
SAMPLING RATE :	16 kHz
SAMPLING RESOLUTION :	16 BITS
RECORD INPUT RANGE :	1.00 Vrms
INPUT 1 LEVEL :	NOT RECORDING
INPUT 2 LEVEL :	NOT RECORDING
PLAYBACK VOLUME :	HIGH

- **CHANNELS** – Selects whether the X200 records audio from a single **MONO** – left channel (input 1) only, or both **STEREO** audio inputs.

SAMPLING RATE – Selects an audio sampling rate of 16 kHz or 8kHz

SAMPLING RESOLUTION – Selects a sampling resolution of 16 bits or 8 bits.

RECORD INPUT RANGE

0.12 Vrms / 0.25 Vrms / 0.50 Vrms / 1.00 Vrms / 2.00 Vrms – This defines the maximum signal that can be accommodated before clipping occurs. If distortion due to clipping is experienced, increase the audio input range. For good noise performance reduce the audio input range until clipping is experienced and then increase the range by one increment.

INPUT 1 LEVEL

INPUT 2 LEVEL

This gives an indication of current audio input level for each channel whilst recording and will be of use when setting the record input range. The level is given in both dB and as a percentage of the maximum input level before clipping. NOT RECORDING will be shown if the X200 is not currently recording.

PLAYBACK VOLUME

LOW / MEDIUM / HIGH / FULL / MUTE – Select the volume level for audio play back via the X201 Reviewer and the line-level output on the rear of the X200.

Motion Detection Menu

MOTION DETECTION	
CAMERA SETUP . . .	
MASK VIEW / EDIT . . .	
ARMING DELAY	OFF
POST – TRIGGER RECORDING:	5 SEC
NORMAL RECORDING:	NO
TIMER RECORDING:	NO
SHOT RECORDING:	NO
ALARM RECORDING:	NO
LINKED NORMAL/ALARM:	NO
SMS MESSAGE:	NONE

The motion detection menu allows the user to define areas of each camera view to be included or excluded from motion detection. A threshold and event count can be set for each camera view in order to control which types of events trigger motion detection recording.

Motion detection can be used to trigger all modes of recording (normal, timer, alarm and shot).

CAMERA SETUP – Enters the camera setup menu, please refer to the camera setup menu section of this manual for detailed information on this menu.

MASK VIEW / EDIT – Displays the currently selected camera view and allows the user to define areas that are to be included or excluded from motion detection.

To select the camera view in question press the relevant camera number key to select that camera. The currently selected camera number key will be lit.

DEFINE THE AREA OF MOTION

Stop key is used to toggle between;

- **inclusive** (green box)
- **exclusive** (red box)
- **bar graph** view/set the current threshold and count levels

Rewind key shrinks the selected area vertically

Fast forward key expands vertically

Play backwards key shrinks horizontally

Play forwards key expands horizontally.

Once the selection area is of the correct size. Pressing the 0 key will activate the selection area for inclusive/exclusive detection. ****This must be done if you are including areas****

Multiple areas can be defined.

Excluded areas are greyed out. By default when the camera view is first selected for masking the entire view is greyed out and is therefore not included in motion detection.

The bar graph displayed by pressing the stop key sets the amount of the included area which needs to change before motion detection recording is activated. This ranges from 0 -25 and is set by using the up and down menu arrow keys. The bar graph is divided into two vertical columns. The left hand column shows a green marker which is the selected threshold level for the current camera view. The right column is the current level of detected motion and can be used as a guide for setting the threshold level.

Some experimentation may be required to determine the optimum threshold level for any given camera view and situation. For example it may be necessary to raise the threshold level in instances where small objects such as cats are triggering motion detection recording and the user is only interested in human sized objects.

ARMING DELAY – This can be set from instantaneous (OFF) to up to 5 minutes in order to allow the user to vacate the detected area before the system becomes active. This may help to avoid unwanted footage of the user being recorded whilst they are vacating the detected area.

POST – TRIGGER RECORDING – This can be set from 5 seconds to up to 2 hours and will determine the amount of time that recording will take place for after a motion event has ceased.

NORMAL RECORDING:
TIMER RECORDING:
SHOT RECORDING:
ALARM RECORDING:

If set to **NO** then the detection of motion will not trigger that mode of recording. If set to **YES** then motion detection will commence the specified mode of recording when motion is detected.

Motion detection will not interfere with the normal operation of any recording mode as specified in the other X200 menus if set to **NO**.

To activate motion detection once setup is complete, press the record button on the reviewer. If no other recording is taking place and motion has not yet been detected, the record light will flash to indicate that motion detection is active, but not currently recording.

LINKED NORMAL/ALARM – This allows the X200 motion to change the recording type. For example you could be recording using Normal record on 1 cam @ 2 IPS, then when motion is detected the X200 can change to Alarm recording on 4 cameras @ MAX RATE. An Alarm input must be set when using this mode.

SMS MESSAGE – On a motion detection, trigger and SMS to be sent.

Camera Setup Menu

MOTION DETECTION			
CAM	DETECT	THRESHOLD	COUNT
1	OFF	0	1
2	OFF	0	1
3	OFF	0	1
4	OFF	0	1

CAM – Lists the camera number in question.

DETECT – If set to **OFF** this camera will not be subject to motion detection control. If set to **ON** the camera will be subject to motion detection control.

If for example normal recording is set to record on cameras 1 – 4 and is selected as **ON** in the motion detection menu, but cameras 3 and 4 are set to **OFF** and 1 and 2 set to **ON** in the **DETECT** setting, then normal recording will be constant on cameras 3 and 4 when normal recording is activated. Cameras 1 and 2 will only record when motion detection is triggered and will record for the duration of the motion event or for a set time afterwards if a post-trigger recording time has been set.

If any individual camera is set to **OFF** then even if the recording mode is set to **ON** in the motion detection menu it will not be controlled by motion detection and will record as per normal and as specified in the relevant X200 menu settings.

THRESHOLD – Sets the level of image change for the selected camera area which will trigger motion detection recording. The range is from 0 (very little change) to 25 (major image change).

COUNT – Sets the concurrent number of frames for which the threshold of image change must have been exceeded before motion detection will be activated. If the count is set to 1 then only one frame will have to have exceeded the threshold for image change before motion detection is activated. If set to 10 (maximum) then 10 concurrent frames will have had to have exceeded the set threshold before motion detection is activated.

This allows short duration events to be filtered out and not trigger motion detection recording if required.

Alarm Recording Menu

ALARM RECORDING		
CAMERAS	IMAGES / SEC	RESOLUTION
1 TO 3	> 3	MEDIUM
4 TO 16	NO RECORDING	LOW
ALARM INPUTS MENU ...		
AUDIO: OFF		
PRE – TRIG WRITE PROTECT:		OFF
POST – TRIGGER RECORDING :		OFF

Camera groups for alarm recording can be created, the number of images per second and resolution of recording can be set for each group.

CAMERAS – Use the up and down menu buttons to move between items in the menu. Pressing the right and left menu buttons next to a camera group will increase or decrease the number of cameras in that group respectively.

Please note that this applies to the X200-16. The X200-04 lists each of the 4 cameras separately.

IMAGES / SEC – These settings are the same as described in the normal recording menu, except they apply only during timer recording.

RESOLUTION – These settings are the same as described in the normal recording menu, except they apply only during alarm recording.

ALARM INPUTS MENU – Pressing the right menu button enters the Alarm Inputs sub-menu.

AUDIO – Specifies whether audio is enabled (ON) or disabled (OFF) for this mode of recording.

PRE – TRIG WRITE PROTECT - OFF / 1 MIN / 2 MINS / 5 MINS / 10 MINS / 20 MINS / 30 MINS / 1 HOUR / 2 HOURS – All files recorded in the specified period before the alarm event are write protected (so they will not be overwritten during loop recording).

POST – TRIGGER RECORDING - OFF / 5 SECS / 10 SECS / 20 SECS / 30 SECS / 45 SECS / 1 MIN / 5 MINS / 10 MINS / 20 MINS / 30 MINS / 45 MINS / 1 HOUR / 2 HOURS – Alarm recording can take place only for the duration of an alarm event (OFF) or can continue for a specified period of time after the event has ceased.

Therefore if an alarm input is only likely to be a momentary event but the ten minutes after that event are also important select 10 MINS for post trigger recording.

Alarm Inputs Menu

ALARM INPUTS			
IN	ACTIVE	FUNCTION	CAMS
1	> CLOSED	NONE	
2	CLOSED	NONE	
3	CLOSED	NONE	
4	CLOSED	NONE	
EMBED ALARM STATE MENU			
CURRENT STATE :		CLOSED	/ OPEN
1	2	3	4

The Alarm Inputs menu defines what the X200 will do when the 4 alarm inputs are either in a closed or open state. Closed is defined as a connection to the '-' terminal of the X200 input/output connector, whilst open indicates that no contact is being made. The 4 inputs are listed in order as shown in the screen shot above, for each of the 4 inputs the following options are available.

ACTIVE – Use the left and right menu buttons to toggle between CLOSED and OPEN. This sets the state which triggers an alarm event and will cause the defined action to take place.

FUNCTION – This defines the action of the X200 when the selected alarm input is active.

NONE – No action.

NORM REC – Switches normal recording on and off instead of the X201 record button.

ALARM REC – Sets the X200 to do alarm recording with the settings for images per second and resolution as defined in the Alarm Recording Menu. The cameras to be recorded can be set in the right hand CAMS column by pressing the right and left menu buttons to raise or lower the current number respectively. In this way an alarm input can trigger recording on a single or a group of cameras. Multiple alarm input triggers will cause camera ranges to be combined.

SHOT REC – Sets the X200 to do shot recording with the settings defined in the Shot Recording Menu. As per ALARM REC a single or group of cameras can be specified.

SWITCHER – Sets the X200 video switcher to view the selected camera for the duration of an alarm event (plus post trigger time if selected). Change the desired camera to be viewed during an alarm event using the right and left menu buttons to change the camera number in the CAMS column.

SWITCHER 2 (X200-16 Only) – Sets the X200 video switcher2 to view the selected camera for the duration of an alarm event (plus post trigger time if selected). Change the desired camera to be viewed during an alarm event using the right and left menu buttons to change the camera number in the CAMS column.

TIMER REC – Sets the X200 to timer recording as per the settings in the Timer Recording Menu.

SMS MSG 1, 2, 3, 4, 5, 6 – Sets the X200 to send one of the user defined SMS text messages if a GSM modem is attached.

GSEN RESET – Resets the GSensor alarm condition.

HEALTH PAGE – Displays the X200 health page for the duration of the alarm.

C1: IMG->GSM – Initiate transfer of **Camera1** image over GSM using setting in the REMOTE SETTINGS menu. Feature can be used with an LED output, see ALARM OUTPUT/LEDs for details. Alarm inputs 1-4 can be used to identify different events, however the image will be take from Camera1.

EMBED ALARM STATE MENU – Jumps to the EMBED ALARM STATE MENU

CURRENT STATE – Shows the current OPEN / CLOSED state of each of the 4 alarm inputs. The corresponding number for each alarm input will be highlighted for CLOSED and not

highlighted for OPEN.

Embed Alarm State Menu

EMBED ALARM INPUT STATE		
ALARM IN	EMBED	TEXT
1	YES	LEFT
2	YES	RIGHT
3	YES	BRAKE
4	NO	
POSITION:	TOP	

The Embed Alarm State menu allows embedded text to be shown as part of recorded images whilst the corresponding alarm input is active.

The alarm inputs active state (closed or open) is set from the Alarm Inputs menu. When active the user defined text is shown in the images at the position designated (top or bottom). The text will be embedded on all camera views simultaneously and will appear on all selected cameras during playback in PCLink200.

The 4 alarm inputs are listed in order as shown in the screen shot above, for each of the 4 inputs the following options are available.

EMBED – Determines whether the text is embedded in the recorded images when the corresponding alarm input is active.

TEXT – Up to 8 characters can be entered in this field to be embedded in the recorded images when the corresponding alarm input is active. The text is entered using the numbered keys on the X201 Reviewer as per the Camera Text menu.

POSITION - TOP embeds the text across the top edge of the recorded images and BOTTOM embeds the text at the bottom of the recorded images above the timestamp and GPS information if these options are active.

Alarm Output / LEDs Menu

ALARM OUTPUT / LEDs	
LED1 OUTPUT :	> RECORD
LED2 OUTPUT :	OFF
ALARM OUTPUT :	> CLOSED
	WHEN . . .

This menu sets the conditions for the external LED outputs and alarm output.

LED1 OUTPUT
LED2 OUTPUT

OFF / FAIL / SERVICE / RECORD / ON / FOCUS / LAN ACTIVE / GSENSOR – The LED outputs can be set to be permanently off or on or to duplicate the state of the fail, service or record LED's on the front panel of the X200. They can also be used to activate a suitable buzzer circuit during camera focussing.

IMG->GSM – When the Image Transfer feature is triggered, the LED output will turn on during the dialling process, flash during data transmission and turn off when complete/ready for next transmission. The only addition to this is that the Service LED will illuminate on a failed transmission (after the re-try process). See REMOTE SETTINGS and ALARM INPUT for further details.

ALARM OUTPUT – CLOSED/OPEN WHEN... This determines whether the X200 alarm output goes closed or open when any of the conditions set in the Alarm Output When sub-menu are met. To access the sub menu press the right menu button next to WHEN...

Alarm Output When Menu

ALARM OUTPUT WHEN....	
FRONT LEDS:	NO
CAMERA DISCONNECTED:	NO
HARD DISK WRITE PROTECT:	NO
HARD DISK FULL:	NO
ALARM OCCURRED:	NO
MOTION DETECTED:	NO
CAMERA FOCUSING:	NO
LAN TRANSFER ACTIVE:	NO
G SENSOR THRESHOLD TRIG	NO

This menu sets the condition for the alarm output.

FRONT LEDS – Can be set to **NO / SERVICE / RECORD** to make the alarm output active if either the service or record LED's are lit on the X200 front panel.

CAMERA DISCONNECTED – When set to **YES** the alarm output is activated when a camera is disconnected from the X200 whilst recording on that camera. The alarm output will become inactive 5 seconds after the camera is reconnected.

HARD DISK WRITE PROTECT – If all the disk is write protected then recording will stop. To give the user warning the alarm output can be used to signal when the disk is either **25% / 50% / 60% / 70% / 80% / 90% / 100%** write protected.

HARD DISK FULL – If all of the disk is full and single pass recording has been enabled then recording will stop. To give the user warning the alarm output can be used to signal when the disk is either **25% / 50% / 60% / 70% / 80% / 90% / 100%** full.

ALARM OCCURRED – When set to **YES** the alarm output is activated when an alarm event has occurred. A battery and sounder may be connected to the alarm output terminals so that the user is audibly informed of any new alarm event. The alarm condition is cleared when the triggering condition has cleared.

MOTION DETECTED – When set to **YES** the alarm output is activated when motion is detected and motion recording has started.

CAMERA FOCUSING – When set to **YES** activates the alarm output for a short duration when the focus improves whilst camera focusing is activated in the CAMERA OPTIONS menu. Please refer to this menu for more detailed information on this process.

LAN TRANSFER ACTIVE – Allows the X200 alarm output to be open or closed whilst files are being transferred via the LAN interface. This may be useful in order to latch a timed power supply in order to prevent power loss to the X200 during transfer.

GSENSOR THRESHOLD TRIG – Alarm OUT is activated when the G Sensor threshold trigger level is reached.

Video Switcher 1 Menu

VIDEO SWITCHER 1	
CAMERA	DWELL TIME
1 TO 4	> 1 SEC
5 TO 16	SKIP
MULTI CAMERA	SKIP
TIME POSITION	NO TIMESTAMP
MULTI CAMERA SETUP . . .	
MULTI CAMERA VIEW . . .	

The video switcher 1 menu controls the automatic switching of cameras on the main video output when the unit is in AUTO mode (selected by pressing the AUTO key on the X201 Reviewer). On the X201 the number key LED is illuminated for the camera shown (1-8 number keys for cameras 1-8 with the addition of the 9-16 LED lit for cameras 9 – 16) and the live picture is viewable on the monitor.

Multi Camera view allows the simultaneous viewing of a number of camera views on the same image and can be included in the switching sequence as per any single camera view.

CAMERAS – Use the up and down menu buttons to move between items in the menu. Pressing the right and left menu buttons next to a camera group will increase or decrease the number of cameras in that group respectively.

Please note that this applies to the X200-16. The X200-04 lists each of the 4 cameras separately.

DWELL TIME – The dwell time can be set from 1 – 30 seconds by using the right and left menu buttons to scroll through the options. Dwell time is how long the switcher will stay on a camera before moving to the next camera. If a camera or group of cameras does not need to be included in the switcher set this option to SKIP.

MULTI CAMERA SETUP – This enters a sub-menu allowing the user to select which cameras are to be displayed simultaneously. Use the up and down menu keys to select the portion of the multi camera screen and the left and right menu buttons to select the required camera number. The Menu Exit key will exit the sub-menu and return the user to the Video Switcher menu. If the timestamp is selected in the TIME POSITION option then it must be noted that this will take up the space of one of the camera views in multi camera view.

MULTI CAMERA VIEW – Displays the multi camera view as per the current settings. Press the Menu Exit key to return to the Video Switcher menu.

***NOTE – Configure the TIME POSITION for your specific output device. The view on the reviewer may not necessarily be the same as the output device.**

Video Switcher 2 Menu (X200-16 Only)

VIDEO SWITCHER 2	
CAMERA	DWELL TIME
1 TO 4	> 1 SEC
5 TO 16	SKIP

The video switcher 2 menu controls the automatic switching of cameras on the switcher video output (X200-16 Only) when the unit is in AUTO mode (selected by pressing the AUTO key on the X201 Reviewer). On the X201 the number key LED is illuminated for the camera shown (1-8 number keys for cameras 1-8 with the addition of the 9-16 LED lit for cameras 9 – 16) and the live picture is viewable on the monitor.

CAMERAS – Use the up and down menu buttons to move between items in the menu. Pressing the right and left menu buttons next to a camera group will increase or decrease the number of cameras in that group respectively.

DWELL TIME – The dwell time can be set from 1 – 30 seconds by using the right and left menu buttons to scroll through the options. Dwell time is how long the switcher will stay on a camera before moving to the next camera. If a camera or group of cameras does not need to be included in the switcher set this option to SKIP.

HARD DISK CARTRIDGE

The use of Hard Disk Cartridges other than those supplied by Timespace Technology will invalidate the warranty of the X200 recorder, and will constitute a breach of the X200 operating software copyright.

The X200 records onto a 2.5" IDE hard disk contained in a cartridge. This cartridge is removable and can be swapped between X200's.

The cartridge contains custom electronics. Only T401-series Hard Disk Cartridges can be used with the X200.

The cartridge is connected to a PC for accessing and archiving files using the USB Interface Kit. Please refer to the section on the USB Interface Kit for detailed instructions.

WARNING: Hard Disk Cartridges are sensitive to shock, vibration and humidity and must be used within operating temperature range as detailed in X200 specification.

X201 REVIEWER



Function

The X201 Reviewer is used to program the menu settings on X200 and to review recordings on the installed Hard Disk Cartridge.

Connect Data Link Cable (supplied with X201 Reviewer) from socket marked "Reviewer" on X200 to socket marked "Recorder" on X201. This connection provides power, video and audio from X200 to X201.

When power (12V \pm 1.2V) is applied to the X200 and fed to the reviewer via the Data Link Cable the red LED on the bottom panel of the reviewer is illuminated.

The X200 display will be shown on the X201 monitor.

Press the buttons on the X201 to control the X200.

WARNING: When X201 is connected to X200 the power supplied to the X200 must be 12V \pm 1.2V.

The X201 has 5 picture adjustment pots situated at the bottom of the left-hand side of the reviewer; these should not under most circumstances need adjusting from the factory settings. If however an adjustment is necessary then please ensure that an appropriate plastic trimmer tool is used in a gentle manner.

These 5 picture adjustment pots are classified as follows.

- i) NTSC Tint (colour balance when using an NTSC feed)
- ii) Colour
- iii) Brightness
- iv) Contrast
- v) Sharpness (image pixel sharpness/smoothness adjustment)

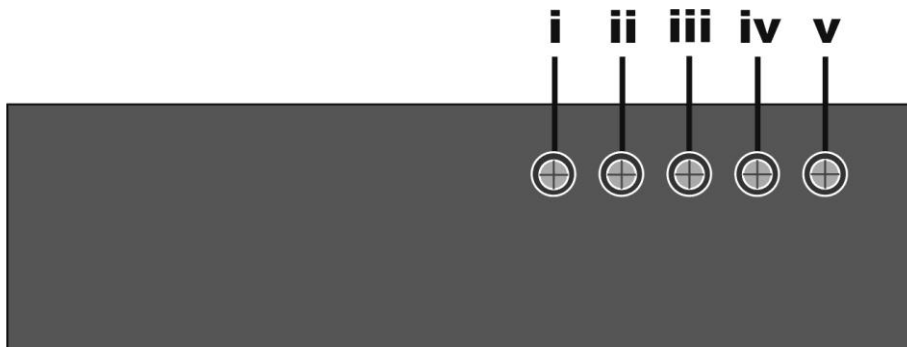

Controls

The keys on the X201 can be grouped into Menu Navigation, Playback & Recording, Camera Switcher and Search & Help.

Menu Navigation

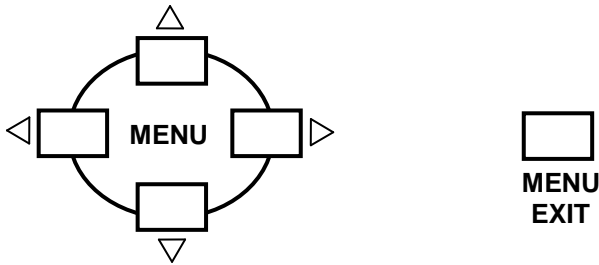

Press any of the 4 menu buttons to enter the main menu. Once in the menu system, their function is as follows:

- △ Move arrow cursor to the previous item.
 - ▽ Move arrow cursor to the next item.
 - ◀ If the arrow cursor is currently at a menu selection, (e.g. **RESOLUTION: > HIGH**), pressing the left button will cycle the value backwards, (e.g. to **RESOLUTION: > MEDIUM**),
 - ▶ If the arrow cursor is currently at a menu selection (e.g. **RESOLUTION: > LOW**), pressing the right button will cycle the value forwards, (e.g. to **RESOLUTION: > MEDIUM**).
- If the arrow cursor is currently at a sub-menu title (e.g. **> OTHER OPTIONS**), pressing the right button will enter this sub-menu.





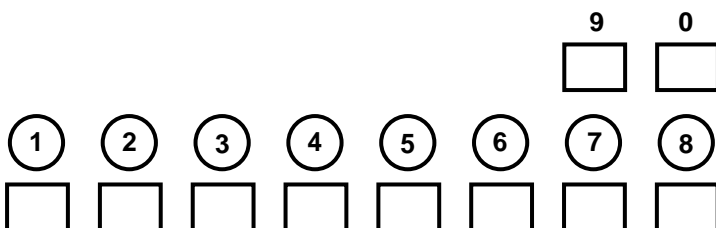

The **MENU EXIT** Key on the X201 reviewer will exit the current menu and move back up 1 level in the menu system when pressed. If already at the top level of the menu pressing this key will exit the menu system completely and return to the video switcher.

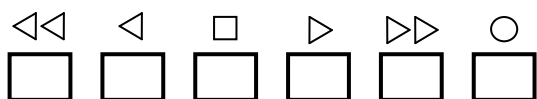
Once in the menu system the numbered keys are used for inputting data into fields which require a user entry such as times and dates.



Playback & Recording



-  **Rewind** through recorded footage. Repeated presses increase the rewind speed in multiples of 1 second, up to a maximum of 20.
-  **Reverse-play** through recordings.
-  **Stop** playback. If playback is already stopped, pressing this button again lights the LED above and the unit is in **Jog** mode, allowing image-by-image playback. Whilst in jog mode, the Rewind and Fast Forward buttons will skip to next/previous file.
-  **Play** recorded footage.
-  **Fast-forward** through recorded footage. Similarly to rewind, repeated presses of the fast forward enable rapid scan.
-  **Record** start or stop. If not currently recording (red LED off), pressing this button will begin recording from the end of the most recent footage. If the unit is currently recording (red LED on), this button will stop recording.

When pressing the control keys above, an **on-screen display** (OSD) will show each action. The OSD times out after 5 seconds. It will also display when switching between files, indicating which mode is being used. Modes displayed are;

Play – normal play
Replay – play backwards
Stop
Pause
Jog
Rewind
Wind – fast forward

Camera Switcher

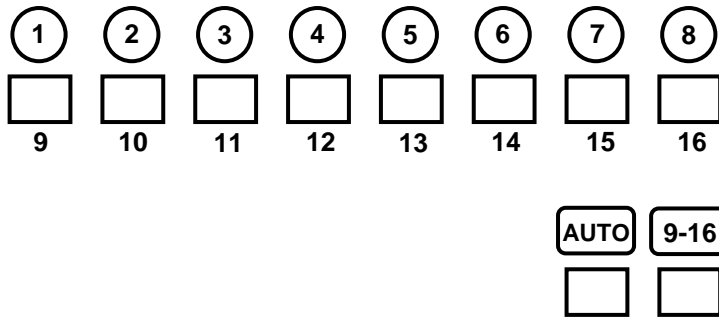

1-8 Switch the view to camera 1 to 8. When playing back recorded footage, pressing buttons 1 to 8 changes playback to that camera. If the AUTO LED is lit, buttons 1 to 8 change the live camera being viewed. This camera is held on the main monitor.

9-16 Press this button before pressing the number buttons 1-8 to access cameras 9-16 on the X200-16.

AUTO Activate the auto switcher mode. In this mode, the monitor will show a live view and the cameras are cycled as specified in the "Video Switcher" menu. Press the AUTO button again to deactivate the auto switcher mode. If any of the buttons numbered 1-8 (or 9-16) are pressed while in auto switcher mode, the camera switching is stopped, and the selected camera view is held on screen.

Control of the auto switcher does not affect any recording in progress.

Search & Help

SEARCH

9 0

HELP

HELP Applies when using any menu. Pressing this button will produce a help screen. Continue pressing any key to cycle through help screens until menu returns.

SEARCH Go to a specific time and date in the recorded footage. Pressing this button will enter the PLAYBACK SEARCH screen as seen below. If the footage on a given camera cannot be found (it may not have been recorded), a "NO FOOTAGE FOR SELECTED CAMERA" message will be displayed.

PLAYBACK SEARCH

TIME : **00 : 00**
DATE : **00 / 00 / 00**

PLAY FROM SET TIME DATE

PLAY OLDEST
PLAY NEWEST

PRESS MENU EXIT TO EXIT MENU

TIME – Use the number keys to enter a time in 24hr format.

DATE – Use the number keys to enter a date in the format DD/MM/YY.

- **PLAY FROM SET TIME DATE** – Plays the footage beginning from the time and date entered. If there is no footage at the time specified a jump is made to the nearest footage to the time given.

PLAY OLDEST – Plays the oldest available footage on the Hard Disk Cartridge.

PLAY NEWEST – Plays the most recent footage available on the Hard Disk Cartridge.

Audio

The X201 Reviewer can also be used for audio playback through its built in speaker. It must be noted that at present playback via the X201 is in mono via channel 1 only.

The audio signal from the X200 is transferred along with the video signal via the reviewer cable to the X201. No other cabling is required.

The speaker is located on the rear panel of the X201 reviewer and a headphone output jack is located on the bottom panel. Volume can be controlled via a trimmer pot located next to the headphone output jack. Very little force and the correct trimmer tool must be used with the volume control to avoid possible damage to the trimmer pot.

USB INTERFACE KIT

The purchase of USB Kit T503/505-USB includes the necessary licence for use of PCLink Suite software including free of charge updates on a single PC (reasonable use policy allows installation on a secondary portable PC; laptop). Timespace Technology does not authorise the unlicensed usage of PCLink Suite software.

Transferring Files to PC

The USB Interface Kit provides all hardware and software necessary to review and archive recordings on a PC from a Hard Disk Cartridge when it has been removed from the X200 Digital Recorder.

No additional device drivers are required for the USB Interface Kit when using Windows 2000, XP, Vista or Windows7. Additional device drivers which can be obtained separately from Timespace Technology will need to be installed if using Windows 98 or Millennium. The USB interface is not compatible with Windows 95 or NT.

Kit Contents

- 1x USB / IDE Interface Lead
- 1x PCLink200 Software CD
- 1x X200 Manual CD (Word document)

Connecting to a PC using the USB Interface Kit

To connect a T401-series Hard Disk Cartridge to a PC via USB you will require a USB Interface Kit which is supplied with the necessary lead, external cartridge power supply, PCLink200 software and Windows drivers.

- 1) Remove the Hard Disk Cartridge from the X200.
- 2) Slide the power switch on the front of the cartridge to the on position.
- 3) Wait for approximately 5 seconds until the LED on the front of the cartridge settles to a steady green colour.
- 4) Plug the multi-pin D shaped IDE USB lead into the rear of the cartridge and then plug the smaller USB connector into an available USB port on the PC.

Once the disk has been connected, the PC should take a few seconds to detect the disk and will then automatically assign a drive letter to it. Recording files can now be viewed by accessing the new drive letter using Windows Explorer or loaded directly from PCLink200 by using the 'Load XBA file', 'Load XBA folder' or 'Cartridge Autoload' options. It is also possible to drag .xba files or folders from a Windows Explorer window and drop them onto the main area of the PCLink200 window.

WARNING - The T505 cable must be removed from the PC between disk swaps. The USB end must be physically unplugged from the PC else the cable will cache disk information and any subsequent disks connected will not read correctly.

Installing USB Interface Kit Drivers (Windows 98 and ME Only)

USB / IDE Interface Drivers only need to be installed when running Windows 98 and ME. They are not included as standard in the USB Interface Kit and can be obtained from Timespace Technology if required.

It is strongly advised that the drivers are not installed when running Windows 2000, XP or Vista as they already have appropriate drivers as part of the original Operating System installation. Windows 95 and NT are not compatible with the USB Interface Kit.

- 1 Switch the cartridge power switch to the 'ON' position. The Power LED will flash amber and then turn green.
- 2 Connect the IDE end of the USB / IDE Interface Lead to the Hard Disk Cartridge and the USB end to an available USB port on the PC.
- 3 Windows should automatically detect the new hardware. Select 'Cancel'.
- 4 Insert the USB / IDE Driver CDROM version CD50.4. Use Windows explorer to open the directory 'USBIDE(ISD)' and then open the directory '98&ME'. Select and run the file 'TPPINST_5_04'. Follow the onscreen instructions to install the drivers.
- 5 Select and run the file 'setup.exe' from the CDROM and follow the onscreen instructions.

PCLink200 software can now be installed from its installation CDROM and used to review and archive footage from a Hard Disk Cartridge. Once PCLink200 has been installed a Hard Disk Cartridge can be connected to the PC by following steps 1 and 2 as described above.

Windows automatically detects and assigns the connected cartridge a drive letter and the drive can be accessed as per normal in Windows Explorer. If Windows has a problem locating a driver or accessing the drive then please refer to the relevant Windows update site and check that all the necessary components for USB compatibility are installed. Windows XP in particular requires at least Service Pack 1 to have been installed and may require further updates for USB compatibility.

PCLINK SUITE

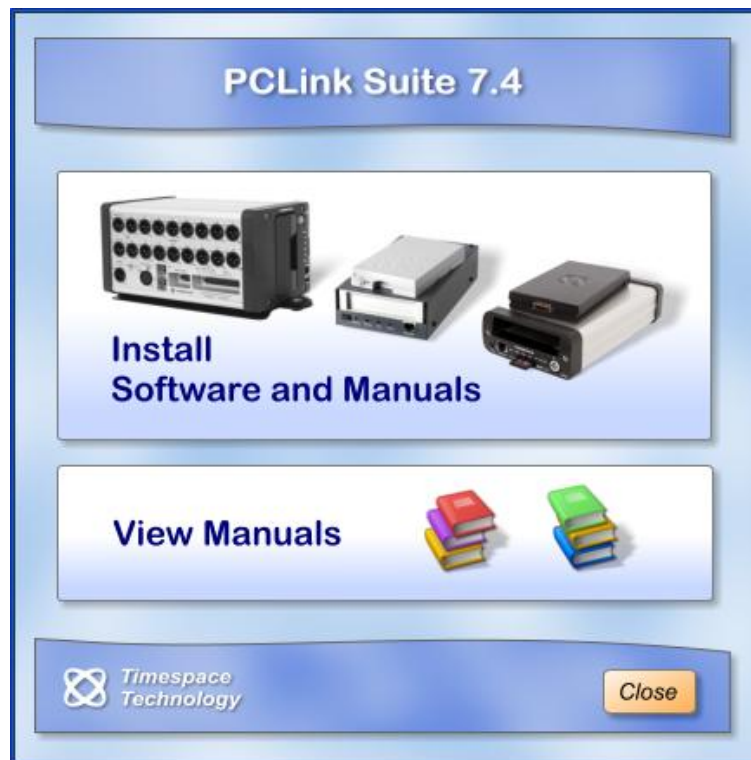

Timespace PCLink Suite consists of applications that allow Playback, Live View, Configuration and Download of recorded files from the X and K series range of digital video recorders.

Detailed instructions of each application within PCLink Suite can be found in the PCLink Suite manual, available on our website www.tspace.co.uk

Application overview;

PCLink200

- Review recorded footage via USB cable connected to removable cartridge.
- Review recorded footage over IP connection to the X300.
- Live view of cameras (multi channel support).
- Remote configuration of X300 menu settings.
- Download file remotely (separate FTP client can also be used to download files).

RemoteLink

- Review recorded footage over GSM / IP connection to the X200.
- Live view of cameras (single channel support).
- Remote configuration of X200 menu settings.

LANLink

- Automatic Health checking over IP connection.
- Automatic and scheduled downloading of footage.

XCommunicate - Download X200 files remotely (single file download support).

ImageLink - X300 can send a snapshot image to a PC using a connected GSM modem.

SafetyLink - Review G-Sensor events that have exceeded the configured threshold.

Below is a quick reference for the main playback software PCLink200.

PCLink200 Quick Reference

The screenshot shows the PCLink200 software interface. On the left is an information side panel with three gauges: Speed (MPH) showing 065, Forward Acceleration (g) showing 0.00, and Lateral Acceleration (g) showing 0.00. Below these are GPS position details: Latitude: N52° 22.47', Longitude: W01° 15.20', Bearing: 162.60° (N), and GPS Rate: . . . There is an 'Open Web Map' button. The main area contains four camera feeds (Camera 1-4) and a map. Each camera feed shows a road view with overlaid GPS coordinates (00015.3254W, 5222.7773N) and speed (65 MPH). The map shows the location with yellow markers. At the bottom, there are playback controls including a speed selector (1.0x), a timeline showing the current time (31 May 2004 17:47:43), and various playback buttons. A PC system resources indicator is visible in the bottom right corner.

Menu bar

Shortcuts

Opens SafetyLink application (driver education program)

Camera number.

GPS position and speed data.

Map information, linked with GPS data.

Time and date information.

Yellow footage position markers can be used to mark the start and end of selected footage (useful for exporting clips)

The playback position marker can be moved to a specific date and.

PC system resources indicator.

GPS speed and motion data, displayed graphically.

GPS position data.

Static map link will open a web browser for location (useful when not using integrated Mapping).

Information Side Panel

Switch between GPS (as shown) FX & G-Force views.

FX View includes; Gamma, Brightness, Contrast, Greyscale and Negative adjustments.

G-Force includes; Lateral, Forward and Upwards measurements in terms of G.

Playback Controls

Playback speed and Volume. Note Volume does not appear unless enabled in the Audio Menu (default is off, as shown).

The date and time of the currently displayed footage.

Play, Stop, Jog Forward/Back, FastForward, Rewind.

Timeline Information

Shows areas of available footage in green. This can be scaled to show footage over appropriate periods of time.

Area's highlighted in red indicate Alarm events.

Motion and G-Force graphs drawn under the timeline when selecting right hand tabs.

REMOTE OPERATION (REVIEW, CONFIGURE AND DOWNLOAD)

The X200 system provides a number of ways of remotely controlling/configuring the recorder, reviewing recorded footage and displaying live camera views.

The X200 includes Ethernet Local Area Network (LAN) technology. It also incorporates a TFTP (trivial file transfer protocol) server which allows the video files to be downloaded using either a hard-wired or wireless network connection. The X200 also includes a serial port allowing direct connection to a PC or system control using a series of RS232 commands. Please refer to the RS232 Control section of this manual for details on RS232 external control of the X200.

There are a number of software applications provided by Timespace Technology in order to achieve these tasks. In addition to these there is a stand-alone TFTP client application (X-Communicate) which is able to download individual recording files via the X200 LAN interface.

Remote Configuration and Live Camera Views

RemoteLink **RS232 SERIAL** **LAN/WLAN/3G** **GSM**

RemoteLink software is provided for this purpose and takes the form of a virtual X201 Reviewer displayed on the users PC. RemoteLink allows the user to configure the X200 menu system, control the recorder functions and look at the current live camera views. Playback of recorded files is possible but is better served by PCLink200.

RemoteLink can connect to the X200 via serial, LAN and GSM modem interfaces. All three of these interfaces provide the same functionality at varying speeds. Direct serial connection is the fastest, LAN is slightly slower and GSM connection is relatively slow compared to the other two due to the bandwidth limitations of the GSM network.

Please refer to the RemoteLink section of this manual for further information.

Remote Streaming of Recorded Footage

PCLink200 **LAN/WLAN/3G**

PCLink200 is able to remotely play back recorded footage from the X200 via the LAN interface without downloading it to the host PC. This allows remote 'streaming' of recordings that may not need to be permanently archived.

Please refer to the PCLink Suite section of this manual for further information.

Automated Recording Download and System Health Check

LANLink **LAN/WLAN/3G**

LANLink software allows multiple X200 systems to be entered and monitored in terms of recording files and system health. LANLink requires a more complex IT infrastructure and systems than the other software but does provide the benefits of remote and automatic download of footage and system health checks.

LANLink works via the X200 LAN interface in conjunction with a dedicated network infrastructure.

Please refer to the LANLink section of this manual for further information.

LAN

Introduction

This document is intended to provide an introduction to the networking facilities provided by the X200 Digital Video Recorder and to assist with the configuration and interoperation between it and other networked computers.

Connection to the X200 built-in 10Mb/s (later units are 100Mb/s) Ethernet network adapter is via a standard RJ45 socket and from this a connection can be hardwired or via a wireless bridge device such as the Netgear ME101.

***Note – For best performance, LAN activity should be kept to a minimum during recording.**

Configuration

Configuration of the X200 networking parameters is done via the menu system accessed using a X201 reviewer. The LAN (local area network) menu option presents the user with fields which allow the IP address, the subnet mask and the default gateway values to be set. It also allows the user to interrogate the unit's unique MAC address.

The X200 LAN menu page is similar to that shown below:

```

LAN

LAN STATUS : DISCONNECTED
IP ADDRESS : > 10. 0. 0 . 200
SUBNET MASK : 255 . 255 . 255 . 0
GATEWAY : 10. 0. 0 . 255

PING TEST . . .

RECORD DURING TRANSFER: NO
LAN IDLE TIMEOUT: 1 MIN
TIME ADJUST PORT: 8463
MAC : 00 : 0F : B4 : 00 : 00 : 00
```

Unit MAC Address

All network devices include a unique media access control (MAC) address used to identify it on a network. The address is a 48 bit number, usually represented as 6 bytes – each byte written in hexadecimal notation.

[On the menu, each hexadecimal byte value is separated by a colon.]

All Timespace Technology devices have a MAC address which begins 00 0F B4 followed by another three bytes.

e.g. 00 0F B4 00 0A 48

The X200 LAN menu option allows the user to display its MAC address which may be useful in configuring access control with wireless networks.

IP Address

For devices communicating on a network, messages must identify the source and destination with an address. The IP (internet protocol) address is a 32-bit number that uniquely identifies a device connected to the network and is usually represented in a dotted decimal form.

e.g. 10.0.0.28

[The IP addressing scheme is defined by the Internet Engineering Task Force (IETF) document RFC 791]

Subnet Mask

The subnet mask is used to determine what subnet an IP address belongs to. An IP address has two components, the network address and the host address. Subnetting enables a network administrator to further divide the host part of the address into two or more subnets. In this case, a part of the host address is reserved to identify the particular subnet.

The subnet mask is the network address plus the bits reserved for identifying the subnetwork. (By convention, the bits for the network address are all set to 1.) As a mask, it can be used to identify the subnet to which an IP address belongs by performing a bitwise AND operation the mask and the IP address. The result is the subnetwork address.

Default Gateway

This is the address of the 'gateway' in a network that a computer will use to access another network if a gateway is not specified for use. In a network using subnets, it is the address of the router that forwards data traffic to a destination outside of the subnet of the transmitting device.

Ping Test ...

Selecting this option will bring up the 'ping test' menu which is similar to that shown below.

```

| PING TEST |
PING ADDRESS:  10.  0.  0.  1
>DO PING TEST |REPLY RECEIVED|
BYTES SENT:           3988
BYTES RECEIVED:       5304
```

Enter the destination IP address of the unit you want to test communication with on the ping address line and then select 'DO PING TEST ...'. If the destination receives the ping message and replies within 10 seconds then 'REPLY RECEIVED' is displayed; otherwise 'NO REPLY' is displayed.

[See the troubleshooting section for further details about 'ping' and instructions on how to initiate a communications test from a computer attached to the network.]

The 'BYTES SENT' and 'BYTES RECEIVED' fields update in real-time to show how many bytes are being transferred to and from the X200 and can provide further indication of data transfer.

WLAN

Wireless Ethernet Bridge

Connection

The X200 Digital Video Recorder is connected to a network via a standard RJ45 network socket. For a wireless LAN, a direct connection can be made from this port to a wireless bridge device, for example Netgear ME101 or WGE101.

Configuration

Because wireless devices from different manufacturers provide different facilities, configuration is usually performed using a proprietary utility supplied with the device. The configuration process usually involves connecting the device to a network equipped PC and running the utility to set up the security and encryption settings. It will also be necessary to select the correct SSID (service set identifier) which is a 32 character string used to identify one wireless network from another. Refer to the installation guide included with the network bridge for more specific details.

Wireless Router

Configuration

Two standards are typically in use for the encryption of data transferred over a wireless network WPA (wireless protected access) and the older legacy system; WEP (wired equivalent privacy). The use of either necessitates the configuration of all wireless devices employed on the network. Where problems are being experienced establishing connection between wireless network devices, it is recommended, where possible, to first establish reliable communication with encryption turned off.

WEP (Wired Equivalent Privacy)

The WEP security standard uses a key (64 or 128 bits long) to encrypt and decrypt data sent over the wireless connection. All devices on the same network must be configured with the same key.

WPA (Wireless Protected Access)

The WPA security standard uses a pass-phrase key to encrypt and decrypt data sent over the wireless connection to ensure privacy. All devices on the same network must be configured with the same key and encryption technique (TKIP or AES).

MAC Address Filtering

MAC address filtering is a security feature which allows you to specify which computers are allowed on your network. Any computer attempting to access the network that is not specified in the filter list will be denied access. When using this feature, the MAC address of each client must be added to the list in the router. It may be necessary to add both the MAC address of the X200 and the wireless bridge to which it is connected.

Typical X200 Wireless LAN Configuration

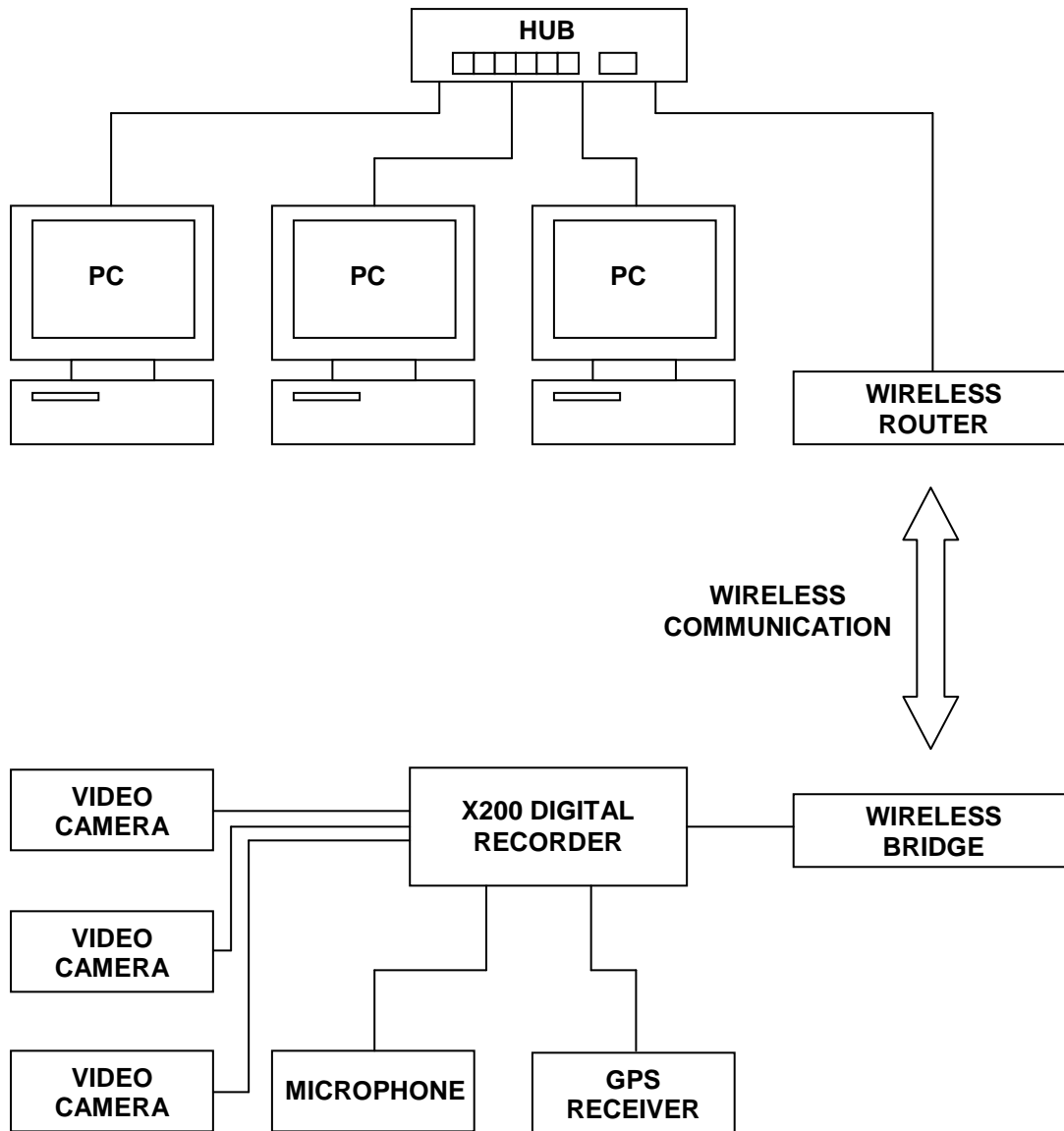

Troubleshooting

Hardwired Connection

If it is suspected that the wireless connection is causing problems, the X200 standard RJ45 socket allows connection to the network using a standard UTP network cable. If a hardwired cable connection is made directly to a single computer then a cross-over cable may be necessary.

Ping

The 'ping' utility is a software tool used to see if a network device is operating and also to see if connections to it are intact. A small packet of data is sent through the network to a particular IP address and the computer that sent the packet then waits (or 'listens') for a return packet. If the connections are good and the target is working, a good return packet will be received.

[Ping uses the Internet Control Message Protocol (ICMP) Echo function which is detailed in RFC 792.]

The 'ping' utility is provided in versions of the Microsoft® Windows® operating system. It can be run by following the instructions below:

- Press the 'Start' button.
- From the menu, select 'Run...'
- In the dialogue window type `command` where it says Open.
- When the command window opens, at the prompt type `ping` followed by the IP address of the device to be tested. In the example below the IP address of the unit being tested is 10.0.0.3 and the unit is replying. If no response is received the ping application will display 'Request timed out.'

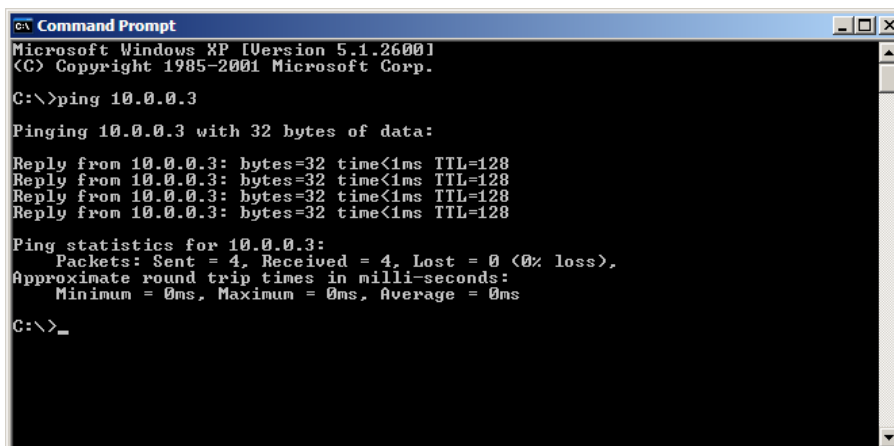

```
Microsoft Windows XP [Version 5.1.2600]
(C) Copyright 1985-2001 Microsoft Corp.

C:\>ping 10.0.0.3

Pinging 10.0.0.3 with 32 bytes of data:

Reply from 10.0.0.3: bytes=32 time<1ms TTL=128
Reply from 10.0.0.3: bytes=32 time<1ms TTL=128
Reply from 10.0.0.3: bytes=32 time<1ms TTL=128
Reply from 10.0.0.3: bytes=32 time<1ms TTL=128

Ping statistics for 10.0.0.3:
    Packets: Sent = 4, Received = 4, Lost = 0 (0% loss),
    Approximate round trip times in milli-seconds:
        Minimum = 0ms, Maximum = 0ms, Average = 0ms

C:\>_
```

Operation

Single Client

The X200 Digital Video Recorder will allow file download to one client at a time. During file transfer, any attempt by another client to download a file will be rejected or ignored. A transfer can be explicitly aborted with a Timespace extension to the TFTP protocol and implicitly aborted if no acknowledgement is received in response to a data packet within 20 seconds.

TFTP

TFTP (trivial file transfer protocol) is a simple protocol used to transfer files. The X200 Digital Video Recorder includes a TFTP server which follows the protocol as described in the following documents:

- The basic TFTP protocol RFC 1350
- TFTP option extension RFC 2347 (1782)
- Block size option RFC 2348 (1783)
- Time-out and transfer size options RFC 2349 (1784)

Timespace Extensions

While the X200 implementation of the trivial file transfer protocol follows the standards closely, it extends upon it to allow the client to interrogate the files stored locally in the recorder. These extensions are:

Explicit transfer abort
Directory listing request

Explicit Transfer Abort

Since the X200 Digital Video Recorder only supports transfers to one client at a time, provision has been made to abort a transfer should either client or source become unable to continue.

The X200 will assume that a data transfer has been aborted if no acknowledgement is received in response to a data packet within 20 seconds.

The X200 will abort a transfer currently in progress if it receives an ABORT command (op code 7). This will allow the same (or another) client to initiate a new transfer.

Directory Listing Request

The standard TFTP read request (RRQ) packet takes the following form:

2 bytes	string	1 byte	string	1 byte
Op Code (1)	Filename	0	Mode	0

The Timespace Technology implementation of TFTP on the X200 responds to read request packets where the *Filename* is either *dir* or *dir, n* (where *n* is an integer used to identify the index into the directory listing). The response to such a request is a packet containing information about the requested directory entry in the following form:

```
iii/nnn→llllllllllllllllllllllllllllll→ssssssssss→ccccccc→mmmmmmmm→zzzzzzzz
```

where the fields are separated by tab characters (→) and they represent:

- i* - the index number of the file in the X200 directory
- n* - the total number of files in the X200 directory
- l* - the long filename
- s* - the short filename
- c* - the creation time and date

m - the modification time and date
z - the file size in bytes.

Data Transfer

Transfer Rate

The X200 Digital Video Recorder is equipped with a 10Mb/s network interface controller and this could be a limiting factor when using with a wireless LAN connection. Current wireless standards include:

IEEE 802.11g – provides networking with speeds up to 54Mb/s

IEEE 802.11b – provides networking with speeds up to 11Mb/s

where these are maximum rates. In practice, the rate adapts according to the S/N (signal to noise ratio) and the signal strength – the further apart the two communicating wireless devices, the lower the transfer data rate.

Transfer Range

The IEEE 802.11b standard limits the radiated power to 0.5W and in general a range of up to 100m is considered possible when there are no obstructions. Besides distance, performance can be degraded by radio interference, humidity, air temperature, resource contention (if many devices are accessing the wireless network simultaneously) and objects that block the signal.

Antenna

Antennas direct Radio Frequency (RF) power into a coverage area. Antennas are available which produce differing coverage patterns and to maximize the transmission range, the design of the antenna connected to your card is crucial. The majority of supplied antennas are omnidirectional - that is, they radiate energy more or less equally in all directions. The correct antenna for a site is chosen by determining the antenna that provides the coverage pattern best matched to the site coverage requirements. If the supplied antenna is replaced with a directional antenna then a range of up to 3km or more may be possible although this will be limited again by any obstructions.

The increase in coverage within the RF beam width is called the antenna gain, and is measured in dB (decibels). Antenna gain improves the range of the signal for better communications (for both transmission and reception). As a general rule of thumb, each 1 dB increase in antenna gain can result in a range increase of 2.5% indoors or 5% outdoors. Actual results will vary depending on the amount and type of obstructions at the site.

Channels

The 802.11 standard defines a number of channels which operate at different frequencies in the 2.4GHz spectrum. However, the spectrum allocation means that many of these channels overlap. Additionally, interference from other devices in the 2.4GHz spectrum, such as wireless phones, bluetooth devices and microwave ovens, can make that part of the airwaves quite crowded.

Channel	Lower Frequency (GHz)	Central Frequency (GHz)	Upper Frequency (GHz)
1	2.401	2.412	2.423
2	2.404	2.417	2.428
3	2.411	2.422	2.433
4	2.416	2.427	2.438
5	2.421	2.432	2.443
6	2.426	2.437	2.448
7	2.431	2.442	2.453
8	2.436	2.447	2.458
9	2.441	2.452	2.463
10	2.446	2.457	2.468
11	2.451	2.462	2.473
12	2.456	2.467	2.478
13	2.461	2.472	2.483
14	2.473	2.484	2.495

Improving Transfer Range

The following tips may help in increasing the transfer range or the signal strength and signal to noise ratio which can help improve the transfer rate.

- Put the router or access point close to the centre of the area to cover.
- Reduce the distance between the wireless devices.
- Keep wireless devices in line of sight, as much as possible.
- Place routers and access points high, and as clear of obstructions as practical. Try to keep antennas at least a metre away from metal fixtures. Note that antennas on roofs do not necessarily give the best results.
- Keep routers, access points, and antennas away from large amounts of water such as fish tanks and water coolers.
- Put routers and access points near windows only if you want to communicate between buildings.
- Avoid the weaker signals heading downward from routers and access points.
- If there is a removable antenna, make sure it is fastened securely.
- For outdoor mounting of antennas note that the coax RF cable should be kept as short as possible to minimize RF loss. Note that the length of cable that comes with the antenna is often optimized.
- Put antennas as close to vertical as practical.
- If there are possible interfering devices nearby (such as mobile phones or microwave ovens) try changing the equipment to use another channel.
- If there are more than one wireless routers in range of each other, space the channels out as much as possible. E.g., for two routers, choose channels 1 and 11. For three routers choose 1, 6, and 11.
- Use access points in areas without coverage.
- In highly critical situations professional installers may be able to help by doing a site survey and following professional installation processes.

Glossary

Bridge	<i>A device which forwards traffic between network segments based on data link layer information.</i>
ICMP	<i>Internet Control Message Protocol</i>
IP	<i>Internet Protocol</i>
LAN	<i>Local Area Network</i>
MAC	<i>Media Access Control</i>
Ping	<i>A software application used to determine whether two network devices are capable of communication.</i>
RF	<i>Radio Frequency</i>
Router	<i>A device in a network that handles message transfer between computers.</i>
SSID	<i>Service Set Identifier</i>
S/N	<i>Signal to Noise Ratio</i>
TCP	<i>Transmission Control Protocol</i>
TFTP	<i>Trivial File Transfer Protocol</i>
UTP	<i>Unshielded Twisted Pair</i>
WEP	<i>Wired Equivalent Privacy</i>
WPA	<i>Wireless Protected Access</i>
WLAN	<i>Wireless Local Area Network</i>

Connecting to the X200 via a GSM Connection

GSM connection to the X200 requires the use of a GSM modem attached to the X200 via a serial connection. The PC dials the GSM modem using the analogue data number of the installed SIM card which may differ from the SIM cards normal phone number as used in a mobile phone. Please contact the SIM card supplier in order to obtain the analogue data number required (this may not be available with all SIM cards and networks).

Before connection can be made using a GSM connection the X200 in question must first be entered into the RemoteLink system.

To add a new GSM connection go to 'Tools' > 'Manage Connections' and select 'Add New'. In the box that appears enter the analogue data number of the SIM card in the GSM modem attached to the X200. A name describing the connection is also added for future reference.

To connect to the X200 via the GSM connection go to 'File' > 'Connect to Unit', select the unit in question from the list and press the 'Connect' button. The unit will be listed by name and phone number.

The PC's modem should then dial the remote unit and make a connection, the X200 menu system should then appear on the virtual reviewer in the RemoteLink window. Use the mouse to click on the appropriate keys as if as per normal operation of an X201 Reviewer.

If the PC has more than one dial-up modem installed the appropriate one can be selected by going to 'Tools' > 'Options' and selecting the modem from the list marked 'Modem Connection Using'.

Ensure that the modem connection speed is set to 9600 or 19200. Please refer to the manufactures manual for your particular model or modem.

Hardware Required for GSM Connection

GSM modem (See recommended modems below, dual-band model suitable for UK and European use)

SIM card (pre-inserted into GSM modem above)

Antenna for GSM modem

Serial cable (see specification below)

Power supply for GSM Modem

X200 with latest software

PC with dial-up modem connected to phone line able to make outgoing calls.

Making a GSM-to-GSM connection

It is also possible to use another GSM modem to dial out from a laptop computer. For example, connect a 2nd Siemens modem (and SIM) to a com port on the laptop, add the modem into Windows modem device manager, then within RemoteLink select the modem from the Tools, Options menu, then connect as per the section above. To add the device in Windows;

- Goto Start>Run, type telephon.cpl
- Click the Modems tab
- Click the Add button
- Check the box "Don't automatically detect, I will pick from a list"
- Select "Standard modem" on the left, then 9600/192,000 on the right
- Click Next
- Pick your com port that the modem is connected to
- Click Finish.

This connection method can also be achieved using a mobile phone, attached to the laptop via a **Bluetooth** connection (subject to mobile phone/laptop capabilities).

Specification of Cabling

RJ12 Power Cable

Pins	Connect to	Function on modem
1	12V	+V
2	12V	free
3	GND	PD_IN (reset input active high)
4	12V	IGT_In (Ignition input active high)
5	GND	free
6	GND	GND

RS232 Serial Cable

Female DType9 Connected to X200		Male DType9 Connected to GSM modem	
Pin		Pin	Function
1		1	DCD
2		2	RX
3		3	TX
4		4	DTR
5		5	GND
6		6	DSR
7		7	RTS
8		8	CTS
9		9	RI

Installation

1 Configure the SIM card

A SIM card needs to be plugged into the GSM modem for it to work. The SIM card provides the GSM modem its identity i.e. its phone number and any account information that may be needed. You may need a mobile phone to configure the SIM card.

RemoteLink requires the user to obtain the analogue data number for the SIM card. The analogue data number is what Remote Link dials to access the GSM unit. Remote Link cannot use the normal mobile phone number that comes with the SIM, but needs a specifically assigned data number obtained from the SIM card provider.

Timespace have only used Vodafone SIMs for which an analogue data number is obtainable from Vodafone (correct as of May 2005). Some SIM card providers may not offer this service and it should be determined whether this is possible before purchasing a SIM card.

To obtain the analogue data number for a SIM card, contact the provider directly. You may need to register with them and you will need to provide them with the SIM card telephone number.

You cannot use the normal mobile phone number of the SIM for GSM modem use. You may also be given a fax number and a digital data number (ISDN number). Neither can be used for the RemoteLink application.

To activate the SIM you will usually need to put it into the mobile phone and make a call to any

phone number. Someone should pick up the call. This initiates the SIM into activity.

If you are dealing with multiple modems it is recommended that you keep a list for each SIM of the SIM number (written on the SIM, 24 - digit) and analogue data number and normal phone number. If a modem doesn't answer, the SIM provider may be at fault - to fix it they will need this information.

Some SIM cards may expire after 3 months or 6 months if no outward calls have been made. It is essential that either the SIM you are using does not expire or the X200 is set to send an SMS message at an appropriate interval. This is set in the SMS OPTIONS sub menu accessed via the REMOTE SETTINGS menu in X200 software V1.3.0 or later.

Sending an SMS message from the X200 in order to keep the SIM card from expiring will be a chargeable event. Please ensure that there is sufficient credit on the SIM to send an SMS message at the determined intervals.

2 Insert SIM card into GSM modem

Press in the little button on the side of the SIM tray using a pen. This pushes the SIM tray out. Remove the SIM from the mobile phone and place it into the SIM tray and slide the tray back into the GSM modem.

3 Connect modem equipment

Connect the modem equipment as shown in the diagram below:

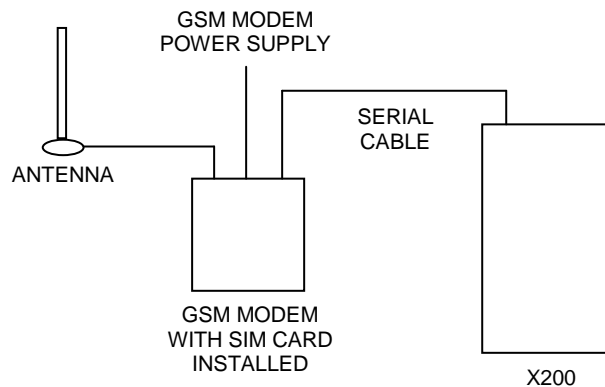

The X200 system can now be switched on, it is ready for dial up.

Ensure that the modem connection speed is set to 9600 or 19200. Please refer to the manufactures manual for your particular model or modem.

Recommended Modems

These are modems that we've tested here:

- Siemens TC35 & TC35i (TC35i requires 19200 baud rate)
- Siemens MC35 & MC35i (MC35i requires 19200 baud rate)
- Fargo Maestro 20

RS232 External Control

The X200 software includes external control via RS232 (rear connector) and provides two enhanced features.

The first is *File via RS232*, which allows files to be created on the X200 hard drive, and read back using the RS232 port on the back of the X200.

The second is *Control Commands via RS232*. This allows many playback and recording functional commands to be carried out by an external device via the RS232 port.

These two features are enabled under the REMOTE SETTINGS menu, by selecting either GSM CONTROL or EXTERNAL CONTROL, for example:

```
RS232: >GSM CONTROL          (default)
RS232: >EXT CONTROL 9600 BAUD external control at 9600 baud
```

Baud rates of 2400, 4800, 9600, 14400, 19200, 38400, 56000, 115200 can be selected. The external commands operate over RS232 port 1 on the rear of the unit. This port is also used for GSM modem control. GSM control cannot be performed at the same time as external control.

Some modern PCs do not come with a serial port, you can however use a USB Serial Adaptor. Two adaptors that we have tested here are:

- NEWLink – www.newlinkproducts.co.uk
- FTDI - FT232R – www.ftdichip.com

The COM port number will vary depending on your PC and which cable you have
For example: on a laptop tested here the NEWLink cable was assigned COM10.

A simple test to check connectivity between PC and X200 you can try following within Windows HyperTerminal;

```
Connect the cables from PC to X200
Make sure that X200 is powered up, installed and switched on
Create a new connection
Connect using COM10 (replace 10 with your own COM number)
Bits per Second – 115200
Data bits – 8
Parity – None
Stop bits – 1
Flow control – Hardware
Clicked File > Properties
Select the Settings tab
Click ASCII Setup > Tick the “Echo type characters locally” check box
```

Then in the main window type #HANDSHAKE – you should receive OK.

Introduction

Handshaking

To check communication with the X200, send #HANDSHAKE<R> and the unit should return OK<R> back. This is a good idea before starting any other commands. It is not a requirement for operation.

The protocol that follows can be operated handshake free, that is commands issued and no response monitored. Alternatively the remote device can monitor the OK<R> messages that are returned.

Tokens

The X200 is always looking for tokens to perform actions. It is usually looking for all the tokens apart from when writing file data. In this case only the "#ENDFILE<R>" is searched for.

Definitions

-	- A space
<>	- Parameter, don't include brackets
<R>	- return (char 13)
FAIL1	- File system failed to create file, aborted
FAIL2	- File name is illegal
OK	- Acknowledgement, Command carried out
CLIENT	- The external equipment that is connected to the X200 via RS232
BAUD Rate	- This shall be selectable from within a menu
<TEXT>	- Textual data

X200 File Via RS232

Writing files

Write File command: **#WRITEFILE,<FILENAME><R>**

Close File command: **#ENDFILE<R>**

A return <R> character at the end of the “#WRITEFILE” command will signify the beginning of the writing process. All data from this point onwards will be written into the file specified.

If the file system fails to create the file for any reason, **FAIL1<R>** will be returned to the client.

A check is done on the file name length, if the user overruns (number of characters in total is greater than 60), **FAIL2<R>** will be transmitted to the client, and the write command is aborted. The user should only use uppercase letters and numbers in the filename and the space character. The extension “.EXT” is automatically applied by the X200, for example

Command	Created file
#WRITEFILE,REPORT<R>	REPORT.EXT
#WRITEFILE,TICKET DATA 3 OCT 2005<R>	TICKET DATA 3 OCT 2005.EXT

If the file has been created effectively, **OK<R>** will be sent to the client. The client may now proceed to send the file data.

When the token **#ENDFILE<R>** is received, the file is closed, and the client will be sent **OK<R>**. A new file may now be opened if required. In the example below, all the text in **BOLD** is written to the file “TICKETS.EXT”

```
#WRITEFILE,TICKETS<R>  
DATE: 7/09/2005  
TIME: 11:48:00  
LOCATION: KINGS CROSS  
#ENDFILE<R>
```

Reading files

Read File command: **#READFILE,<FILENAME><R>**

A return <R> character at the end of the **#READFILE<R>** command will signify the beginning of the reading process. Data will now be transmitted from the X200 to the client. The handshaking line CTS on port 1 may be used if required to pause the data flow. If the file system fails to open the file for any reason, **FAIL1<R>** will be returned to the client. A check is done on the file name length, if the user overruns, **FAIL2<R>** will be transmitted to the client, and the read command is aborted. If all is good, **OK1<R>** is sent followed by the file data followed the token **#ENDFILE<R>**. The following example reads the file “TICKETS.EXT”.

<u>Sent to X200</u>	<u>Received from X200</u>
#READFILE,TICKETS<R>	DATE: 7/09/2005
	TIME: 11:48:00
	LOCATION: KINGS CROSS
	#ENDFILE<R>

X200 Control Commands Via RS232

Handshaking

All commands sent to the X200 are acknowledged, for example if the client sends #RECSTART<R>, **OK<R>** will be returned to the client to signify that the command was successfully carried out. In the case of commands like GETTIME and GETDATE, **OK<R>** will not be returned, but the data requested, followed by a <R>. In the case of PREVIOUSFILE and NEXTFILE, **OK<R>** will be replaced with either **LAST<R>** or **FIRST<R>** if there are no more files to play next or previous, respectively. When sending commands, the sender to the X200 can wait for an OK before sending another command, or one of the other variants listed above.

Delay between commands

There may be a need for a hold off time between certain commands (e.g 10 mS), as the X200 may take a finite time to do certain tasks. To add delay you could simply put spaces between one command and the next and these are ignored. The X200 does have a FIFO queue of 2048 bytes so can buffer data. Certain commands can be followed immediately with other commands for example:

```
#CAMERA_<1-16><R>#PLAY<R>           -play a given camera
#SETTIME_<12:23:45><R>#SETDATE_<23/09/05><R> -set time and date
```

Recording

If for any reason recording stops, even if instructed to, the X200 will return **#RECSTOP<R>**

#DISKREMOVED<R> will be sent under two conditions.

- 1) The disk is removed from the X200 at anytime post X200 initialization.
- 2) Live view always has been enabled and the X200 boots without a disk.

#DISKIN<R> will be sent under two conditions.

- 1) The disk is inserted into the X200 at anytime post X200 initialization.
- 2) Live view always has been enabled and the X200 boots with a disk.

Control Commands

#RECSTART<R>	- start recording
#RECSTOP<R>	- stop recording
#STOP<R>	- stop playback
#PLAY<R>	- start playback (standard)
#REPLAY<R>	- play backwards (standard)
#WIND<R>	- fast forwards (standard)
#REWIND<R>	- rewind (standard)
#XPLAY_<FACTOR><R>	- plays at the specified factor speed (-/+)
#CAMERA_<1-16><R>	- camera to control
#LIVEVIEW<R>	- switch to live view
#AUTOLIVEVIEW<R>	- switch to live view automatic mode
#JOGFORWARD<R>	- one frame backwards
#JOGBACKWARD<R>	- one frame forwards
#GOTONEWESET<R>	- go to the newest recording
#GOTOOLDEST<R>	- go to the oldest recording
#GOTO_<DD/MM/YY_HH:MM><R>	- go to time DD:MM:YY_HH:MM
#GOTO_<DD/MM/YY_HH:MM:SS><R>	- go to time DD:MM:YY_HH:MM:SS
#SETTIME_<HH:MM:SS><R>	- sets the time
#SETDATE_<DD/MM/YY><R>	- sets the date
#GETTIME<R>	- gets the time
#GETDATE<R>	- gets the date

#NEXTFILE<R>	- when playing, skips to the beginning of the next file
#PREVIOUSFILE<R>	- when playing, starts at the beginning of the currently playing file. When stopped and #PREVIOUSFILE is issued twice, followed by a play, the previous file will begin playing from the beginning.
#GETFILETIMEDATE	- gets the current playing position of the currently play file.
#GETSTATS	- returns statistics
#DELETEALLREC	- removes all recording files from disk
#LED1_0/1	- Turns LED 1 output ON (1) or OFF (0)
#LED2_0/1	- Turns LED 2 output ON (1) or OFF (0)
#ALARMOUT_0/1	- Turns ALARMOUT LED Output ON (1) or OFF (0)
#ALARMIN1_0/1	- Sets the state of the Digital input 1 ON(1) or OFF(0)
#ALARMIN2_0/1	- Sets the state of the Digital input 2 ON(1) or OFF(0)
#ALARMIN3_0/1	- Sets the state of the Digital input 3 ON(1) or OFF(0)
#ALARMIN4_0/1	- Sets the state of the Digital input 4 ON(1) or OFF(0)
#CAMTEXT_<1-16>_<TEXT><R>	- Writes text to the console at record time, Char 255 moves to the beginning of a new line. Maximum 49 characters per camera.
#DISKSTATUS	- Returns #DISKREMOVED or #DISKIN to signify the disk status.
#MODESTATUS	- Returns #RECORD, #PLAY or #IDLE to signify the status of the X200.
#SETCAMTEXT_<1-16>_<TEXT><R>	- sets the camera text as via the Camera Options menu on the x200. 1-16 is the camera selection followed by the actual text. This is fixed to 12 characters per camera.
#SETFILETEXT_<TEXT><R>	- sets the filename text for the x200 file system to use. Max 12 characters.
#LOGRESET<R>	Resets the service log
#LOGREAD<R>	Reads the service log and returns up to the 10 latest entries

The following are variants of existing commands and are for reading their values.

#LED1<R>	- Returns the status of LED1, Returns 0 or 1
#LED2<R>	- Returns the status of LED2, Returns 0 or 1
#ALARMOUT<R>	- Returns the status of ALARMOUT, 0 or 1
#ALARMIN1<R>	- Returns the status of ALARM Input1, 0 or 1
#ALARMIN2<R>	- Returns the status of ALARM Input2, 0 or 1
#ALARMIN3<R>	- Returns the status of ALARM Input3, 0 or 1
#ALARMIN4<R>	- Returns the status of ALARM Input4, 0 or 1
#MULTIVON<R>	- Turns Multiview On
#MULTIVOFF<R>	- Turns Multiview Off
#LOG_<TEXT><R>	- Logs a text message to the X200's service log (does not light service LED). Sending RESET LOG as the text marks off there LanLink should read the messages up to. OK<R> is returned if the daily quota of 10 has not been reached, other wise 10/DAY<R> is returned

Command in Detail

#GETFILETIMEDATE

Gets the current playing position of the currently playing file. Please use #MODESTATUS to tell if the time you are reading is live play or if in idle mode, as the time you receive will ways be the current/last position played.

#GETSTATS

Will return the following stats in the same format. #END<R> signifies end of file. The stats may possibly grow in the future, but will be append to this list. Scanning for #END after the data has been retrieved. Data may be scanned for by capturing just after the colon (:) and just before the end of line <R>

```
Capacity: 30.01GB
Used: 0%
Write Protected: 0%
First File: DD/MM/YY_HH:MM:SS
Last File: DD/MM/YY_HH:MM:SS
Model Number: model number
Serial Number: serial number
#END<R>
```

#DELETEALLREC

The #DELETEALLREC command will stop the current recording and delete all recording files. When complete, OK<R> will be returned

#LED1, #LED2, #ALARMOUT

The following 3 commands control the 2 digital outputs and the Alarm output. These settings will be OR'd with the current hardware states of the X200.

```
#LED1_0/1<R> – Turns LED1 ON or OFF
#LED2_0/1<R> – Turns LED2 ON or OFF
#ALARMOUT_0/1<R> – Sets the active state for the alarm output CLOSE/OPEN.
```

The following commands will READ the status of the LED and ALARM out ports:

```
#LED1<R> - Returns the status of the LED1 port, 0 = off, 1 = on
#LED2<R> - Returns the status of the LED2 port, 0 = off, 1 = on
#ALARMOUT<R> - Returns the status of the ALARMOUT port, 0 = off, 1 = on
```

#ALARMIN1, #ALARMIN2, #ALARMIN3, #ALARMIN4

Each one of the alarm inputs can be virtually activated by using the following commands, which control each alarm input independently. These settings will be OR'd the current hardware states of the X200.

```
#ALARMIN1_0/1<R>
#ALARMIN2_0/1<R>
#ALARMIN3_0/1<R>
#ALARMIN4_0/1<R>
```

By using these commands, a camera may be assigned to each alarm input, thereby allowing recording on each channel to be selective and/or allow for a different set of recording rates between Normal and Alarm recording

The following commands will READ the status of the ALARMIN pots:

#ALARMIN1<R> - Returns the status of the ALARMIN1, 0 = off, 1 = on
#ALARMIN2<R> - Returns the status of the ALARMIN2, 0 = off, 1 = on
#ALARMIN3<R> - Returns the status of the ALARMIN3, 0 = off, 1 = on
#ALARMIN4<R> - Returns the status of the ALARMIN4, 0 = off, 1 = on

#CAMTEXT

#CAMTEXT_1_HELLO WORLD<R> - "Hello world" will be written at the top left hand corner
#CAMTEXT_3_<255><255><255>HELLO<R> - "Hello" will be written on the 4 line on camera 3

If text has been assigned to a camera, simply issuing blank text will clear all RS232 overlay text from that camera. A maximum of 49 characters may be sent to the screen including new line control codes. E.G #CAMTEXT_3_<R> will clear the text (***please note the space after 3***)

#SETCAMTEXT_<1-16>_<TEXT><R> Sets the camera text as via the **Camera Options** menu on the x200. 1-16 is the camera selection followed by the actual text. This is fixed to 12 characters per camera.

#SETFILETEXT_<TEXT><R> Sets the filename text for the x200 file system to use. Max 12 characters.

#LOGRESET<R> Resets the service log

#LOGREAD<R> Reads the service log and returns up to the 10 latest entries

Examples

CAMERA_1<R> switch to camera 1 (either in live/auto view or during playback)
XPLAY_0.5<R> plays forward at half speed
XPLAY_-3.2<R> plays in reverse at 3.2 times real time rate
XPLAY_10<R> plays forwards at 10x speed
SETTIME_12:23:23<R> sets the time in the format HH:MM:SS
SETDATE_23/09/05<R> sets the date in the format DD:MM:YY
#GETTIME<R> to which 12:23:23<R> is returned
#GETDATE<R> to which 23/09/05<R> is returned
#LED1_1<R> turn LED1 on
#CAMTEXT_1_Hello><R> writes "Hello" to the console at record time in the top left corner.

Note: The windows demonstration tool "Shuttle command tester" is available with source code.

TRANSPORT FOR LONDON IBUS DIAGNOSTIC INTERFACE

Timespace has developed a diagnostic interface in conjunction with Transport for London (TFL) to monitor the status, performance and health of Timespace X200, X300 and V400 digital video recorders on London Buses.

Data strings are passed between the DVR and the IBUS system every 5 mins. In addition to the scheduled data packets, the DVR can be queried by sending it a proprietary text string. Several different data sets can be retrieved according to the input string.

The IBUS feature is available in software **X200 V1.9.0** onwards, **X300 V1.1** onwards and **V400 V1.0** onwards. The IBUS menu is accessed using the short code; **9001234** on the X200 and X300 and via the menu system on the V400. The short code can be entered from any menu using the number keys on the X201 Reviewer.

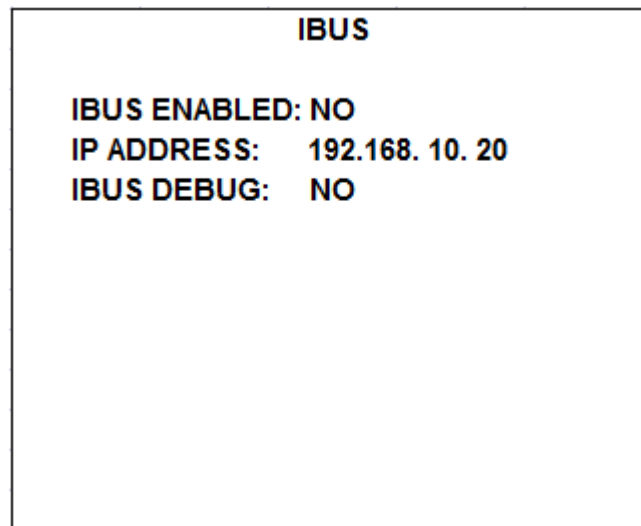

IBUS ENABLED - The IBUS interface can be enabled/disabled by setting YES/NO accordingly.
IP ADDRESS – Sets the IP address of the receiving device (default IBUS IP as above).
IBUS DEBUG - For testing purposes a debug mode can be enabled. This will increase the rate of messages sent out from the DVR to every 5 seconds. It is not recommended to leave debug turned on during normal operation.

The IBUS information can also be accessed using the RS232 command #IBUS. This command is only supported on the X300 & V400 over the serial port, no Telnet support.

Example setup of the IBUS interface on an **X200** DVR includes;

- Set recording parameters as required.
- Enter IBUS short code and set ENABLED to YES
- Navigate to the ALARM OUTPUT when... menu and set CAMERA DISCONNECTED to YES.
- Navigate to the LAN menu and set the IP ADDRESS to 192.168.10.30 and the GATEWAY to 192.168.10.20

Example setup of the IBUS interface on an **X300** DVR includes;

- Set recording parameters as required.
- Enter IBUS short code and set ENABLED to YES
- Navigate to the LAN menu and set the IP ADDRESS to 192.168.10.30 and the GATEWAY to 192.168.10.20

Example setup of the IBUS interface on a **V400** DVR includes;

- Set recording parameters as required.
- Enter IBUS menu and set ENABLED to YES
- Navigate to the LAN menu and set the IP ADDRESS to 192.168.10.30 and the GATEWAY to 192.168.10.20

It is advised to set the correct date and time when enabling the IBUS feature and ensure no Service/Fail conditions are currently being displayed. **NB** currently the X200, X300 and V400 connect to the IBUS system's network port 4. In the case of the V400, LAN socket 1 is currently used for the IBUS interface.

XP200 ACCELEROMETER

The Timespace XP200 Accelerometer is designed to integrate seamlessly with the X200 Digital Video Recorder.

Acceleration in X, Y and Z axes is stored and displayed with each recorded image and GPS position. High G events can be quickly identified and reviewed.

All Timespace products are designed for easy integration and simple, reliable operation. In addition, the XP200 can be used to power the X200 DVR on/off when movement is sensed.

Specification

1 GND	
2 12V In	12V at 50mA relay on, 12V at 10mA relay off, 6V to 18V max input,
3 12V Out	Relay output. Maximum switching current 8A (12V out connected to 12V in)
4 Ignition	Voltage above 4V turns relay 12V Out on. Voltage below 4V initiates duration settable timer after which 12V Out is off (open circuit)
5 Serial Out	Connect to X200 RS232 input pin 9 (Serial Rx) 19,200 baud.
6 GPS In	Wire GPS serial output to this pin. GPS data merged with Acceleration data and output on Serial Out. GPS needs to output at 19,200 baud.
Connector	3.81mm 6 way block. Farnell part no. 370-5031 (supplied with XP200).

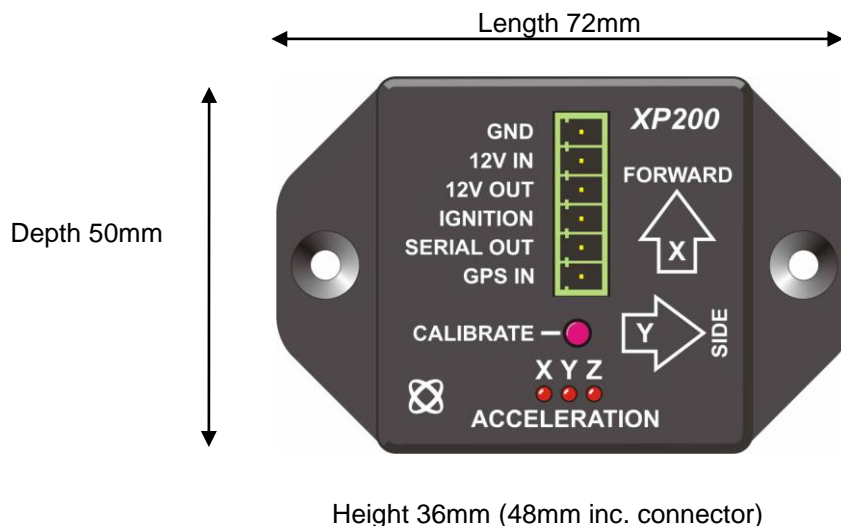

Operation

Minimal Accelerometer

Wire 12V in, GND and serial out. Acceleration data sent to X200 via serial port

Accelerometer with Power Switching on vibration

Wire 12V in, GND, serial out and connect 12V out to X200 and cameras. On any small force (e.g. vehicle motion) unit turns on relay to power system (e.g. when vehicle leaves depot). Unit will power off after 3 hours (duration configurable) of no motion (when vehicle is stationary). Force level to cause turn on is 0.05G on any axis.

Accelerometer with Power Switching on vibration and ignition

Wire 12V in , GND, serial out, connect 12V out to X200 / cameras and also wire vehicle ignition signal to ignition input. Relay will power on if ignition is on or vehicle is experiencing motion. Relay will power off after 3 hours (duration configurable) of no motion and ignition off.

Power Switching on relay input (as X100)

This may be used to turn main power on using an alarm input while consuming 10mA in standby. This provides the low power mode similar to that built into legacy X100 units but not available on X200 units. Wire 12V in, GND and 12V out to X200 / cameras. Wire the relay alarm input between 12V in and IGNITION pins.

Calibration

Once the unit has powered up (noted by running LEDs from left to right, and right to left)

PROGRAMMING

Phase 1 - Calibrating X,Y,Z axes

1. Place the unit flat on the desk (text facing up)
2. Holding unit steady, Press and hold the CALIBRATE button for 5 seconds until all 3 LEDs flash once (PHASE 1) momentarily, followed by a steady Z LED.
3. Release the button, Z axis has now calibrated. Y LED will light.
4. Place unit on its Y Axis - Y Arrow pointing downwards.
5. Holding unit steady, Press and Release CALIBRATE button, Y axis has now calibrated X LED will light.
6. Place unit on its X Axis - X Arrow pointing downwards.
7. Holding unit steady, Press and Release CALIBRATE button, X axis has now calibrated X LED will light.

N.B. When calibrating on side, balance on main body not flange

Phase 2 - Selecting Post Motion Power on Timer

1. All 3 LEDs will flash twice. (PHASE 2)
2. Press the button as many times as you require the units to Post Motion Trigger measured in HOURS. (1 to 10 times representing 1 through 10 hours).
3. Once the desired hours has been selected, leave the unit alone for 5 seconds, and it will replay your selection by flashing all the LEDs the same amount of times you selected. The default count if no button(s) pressed during this time is 3 (i.e. 3 Hours)
4. The units has now programmed - after programming no LEDs should light while on a level surface.

On all axes, if a force of greater than 0.25G is measured, the appropriate axes LED will light until less than 0.25G again. The XP200 runs at 19200 baud In-Line with GPS. GPS is NOT required, but will operate together. Select 19200 bps on the X200 GPS menu.

SPECIFICATIONS

X200 DIGITAL RECORDER

Video Recording

Max Rate	25ips PAL, 30ips NTSC, shared; selectable by camera
Resolution	Low, Medium, High, V.High
TVL	540
Pixels	720 x 288 PAL; 720 x 240 NTSC
Format	MPEG - full image update or optional conditional refresh
Input Signal	4 or 16 inputs; composite video 1V p/p; colour/mono; PAL/NTSC auto-switching
Simultaneous Functions	Record, Playback, Live views, Ethernet
Recording Medium	2.5" IDE PC-compatible hard disk in customised cartridge
Recording Modes	Normal, timer, alarm, single/multi shot, loop or single pass
Alarm recordings	Post-trigger recording; show alarmed cameras live on video switcher, pre-trigger write protection of existing recordings
Timer recording	Weekly timer (7 day programmable) or interval timer, or both
Motion Activation	User configurable for cameras, areas and sensitivity
Embedded Text	Camera number, date and time plus 12 user characters for each camera; GPS* speed and position
Camera Focus Mode	External indication of relative camera focus

Audio recording

Type	Mono or Stereo
Connections	2 line inputs; 2 line outputs
Sampling Rate	16kHz/8kHz
Sampling Res.	16 bits/8 bits
Max Level	Selectable: 0.12V to 2V RMS (0.35V to 5.6V pk-pk)

Configuration

Entry	Menu system with help screens; accessed (with password) by X201 Reviewer
Password	4 user-definable levels
Date Options	dd/mm/yy; mm/dd/yy
Summertime Correction	UK; Europe; USA; Off

File System

File Type	Proprietary ".xba", convertible (with password) to AVI
File Name	Optional file text plus date/time, for example:"Bus0034 2004 month 08 day 16 12_30_00. xba"
File Size	10 min or 1 hour
File Protection	Write-protection via file menu; optional automatic write-protection of alarm/shot recordings

Playback

Functions	Rewind, Replay, Stop, Play, Fast Forward, Jog mode
Image Search	Time/date or by file

Remote Operation*

Systems	Ethernet (LAN/WLAN*) GSM*, RS232
Functions	File transfer to PC (LAN/WLAN*) Configuration of X200 (GSM*, RS232) Shuttle commands (GSM*, RS232) Live camera views (GSM*, RS232) Automatic file download (LAN/WLAN*)

GPS*

Embedded Text	Position (coordinates) and speed (kph or mph)
GPS Data	Files contain GPS position/speed/time for mapping
Clock Lock	Locks X200 clock to world GPS clock

Connections/Controls

Connector Type	Cable harness (X200-16) Individual connectors (X200-04)
Video Inputs	16 on 25-way "D" connectors (X200-16) 4 x BNC (X200-04)
Video Out	1 on 25-way "D" connector (X200-16) 1 x BNC (X200-04)
Video Switcher Out	2 on 25-way "D" connector (X200-16) 1 on BNC connector (X200-04)
Audio In	2 line on 25-way "D" connector (X200-16) 2 line on DIN 5 way audio socket (X200-04)
Audio Out	2 line on 25-way "D" connector (X200-16) 2 line on DIN 5 way audio socket (X200-04)
Alarm Inputs	4 on screw terminals
Alarm Output	1 on screw terminals
Power Inputs	2.5mm DC socket for PSU, 1 x pair screw terminals, 12V
GSM*/GPS*/RS232 Control	9-way "D" connector (RS232 serial)
LAN/WLAN*	RJ45 (rear panel)
Reviewer [X201]	RJ45 (front panel)
Record On/Off	Push button (menu disable)
Indicators LED	Power, Recording, Service, Fail
LED Out	2 x screw terminals to duplicate Recording, Service, Fail and Power LED

General

Security	Proprietary files; password protection; fragile watermark every image (MD5+DES); embedded camera text
Power [DC]	12V DC nominal
External PSU Specification	Output: 12V DC Regulated, 2A (Continuous) 3A (Peak)
Power Recording	0.60A, 12V (7.2W)
Power Not Recording	0.48A, 12V (5.8W)
Peak Current	2.8A peak start-up current @ 12V (X201 connected)
Power on until Recording	< 5 seconds
Clock	TCXO (+/- 1 min/year); optional GPS locked clock*
Case	Mild steel, grey painted
Dimensions [mm]	210 x 112 x 47 (case)
Dimensions [mm]	220 x 116 x 52 (overall)
Weight	965g (without cartridge)
Environment	Indoor use
Operating Temp. Range	+5C to + 40C, 20% to 80% RH Storage Temp. Range -40C to +65C
Mounting	Free-standing or screw-mounted
Warranty	36 months

Approvals

EMC	89/336/EEC Generic 95/54/EC Commercial Vehicles Specification 5 UK Home Office
Electrical Safety	72/23/EEC

* Additional hardware required - not supplied by Timespace Technology

REMOVABLE HARD DISK CARTRIDGE

Access	X201 Reviewer/LAN/WLAN* while in X200, PC using Interface Kit (see below)
Hard Disk	2.5" IDE
Power Requirement	5V 1A (PSU supplied with USB Interface Kit)
Dimensions [mm max.]	143 x 84 x 23
Weight	~ 200g depending on type
Warranty	30 months

X201 REVIEWER

Functions	Program menus, check camera views, review live or recorded images
Operation	22 tactile keys with LED indicators
Power	Powered by X200
Power Consumption	0.35A, 12V (4.2W)
Display	4" (102mm) LCD monitor, TFT, 960(H)x234(V) pixels
Format	PAL/NTSC
Audio	Single channel via built-in speaker
Connectors	X200 interface: 8-way RJ45 (serial data; video; audio; DC supply); headphone jack
Case	Aluminium, grey painted
Dimensions [mm]	218 x 148 x 52
Supplied Accessory	Data link cable (X200 to X201)
Warranty	36 months (monitor 12 months)

PCLINK200 REVIEWING/ARCHIVING SOFTWARE

Availability	Supplied in Interface Kits; software available to law enforcement agencies
Compatibility	Recordings made by X200
Access	Cartridge or recordings on CD/DVD, PC hard disk (copied or LAN/WLAN* uploaded files). Direct LAN/WLAN* access of recordings on HardDisk Cartridge installed in X200. Automatic LAN/WLAN* file download software (LANLink)
Operating Systems	Windows 98, ME, 2000, XP, Vista.
Hardware Requirements	2GHz Pentium, 256MByte RAM, USB2
Security	Optional password on PCLink software and on export video to AVI function
Playback Controls	Rewind, jog back, stop, play and fast forward, jump to time, rapid shuttle via timeline.
Playback Speed	Variable x0.1, x0.2, x0.5, x1, x2, x3, x4, x6, x8, x10 realtime for rapid playback.
Functions	Realtime playback with audio Review archive files on single/ Multi-screen Full screen playback view Copy 10 min or 1 hour files from cartridge to PC Copy images into Microsoft Word etc. Activate and verify watermarks Export video in multiple CD/DVD sized files Stand-alone (no install reqd.) playback software Export video to AVI file

OTHER ACCESSORIES

USB INTERFACE KIT

For access to X200 recordings via USB2 socket of PC; includes software, cables, instructions, PCLink200 software.

VEHICLE MOUNTING KIT

Shock and vibration protection in mobile and portable applications.

TROUBLESHOOTING

Text Messages

The following messages may be displayed on the X200 reviewer under the circumstances described:

MANUAL OVERRIDE ENABLED

You have chosen to override ALARM recording and turn recording off.

To disable this manual override, press the record key again, after leaving this screen.

PRESS ANY KEY TO CONTINUE

The above is displayed when the unit is configured for alarm recording and the record button is pressed which will override the configured mode. Press any key on the reviewer to clear the message.

MANUAL OVERRIDE ENABLED

You have chosen to override TIMER recording and turn recording off.

To disable this manual override, press the record key again, after leaving this screen.

PRESS ANY KEY TO CONTINUE

The above is displayed when the unit is configured for timer recording and the record button is pressed which will override the configured mode. Press any key on the reviewer to clear the message.

MANUAL OVERRIDE DISABLED

Manual override is now OFF.

PRESS ANY KEY TO CONTINUE

The above is displayed when manual override has been enabled and then subsequently disabled again. Press any key on the reviewer to clear the message.

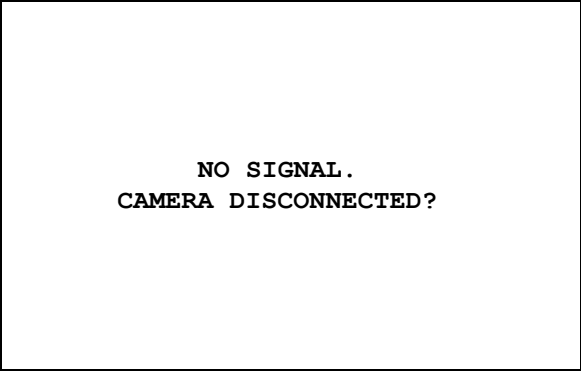

NO SIGNAL .
CAMERA DISCONNECTED?

The above message is embedded within the recording file when the X200 video recorder detects that there is no video signal on an input selected for recording. Check that the camera is working and properly connected to the X200 should this message be seen unexpectedly in recordings.

Fail LED

Illuminated when the X200 video recorder is unable to make recordings. Check that the hard drive cartridge is properly inserted and locked in.

Service LED

If the Service LED is lit then the system will most likely be functional but may not be performing as intended. The system should be checked and any remedial action taken as soon as possible.

The problems in question will be listed in the service log which can be viewed in the statistics menu by selecting 'View Service Log'. The Service LED will remain lit and the problem which caused the Service LED to light will be listed in the log until the log is reset by selecting 'Reset Service Log'.

The service log should only be reset once the cause of the problem has been verified and rectified.

FAQ's

X200

"Does not record on power up"	Enter menu system; go to OTHER MENU, ADVANCED MENU; set to "RECORD AT POWER UP".
"Recording at varying times"	Check that the TIMER RECORDING MENU settings are correct or Timer Recording is disabled.
"The recorded picture is grainy"	Improve the light level to the camera, or increase the exposure level; use a camera which works to a lower lux level.
"X200 has all front panel LED's illuminated and fails to operate"	Ensure cartridge is pushed home and switched on.
"Cameras connected but no live views"	Press "Auto" on the X201 Reviewer.
"No picture on X201 monitor"	Ensure that correct power supply to X200 (12V +/- 1.2V, 2A (continuous) 3A (peak)).
"PC can't see disk but recordings viewable on X200"	<p>The hard disk boot / partition / FAT sectors may have become corrupted. Go to OTHER MENU, FILE SYTEM, FILE SYSTEM CHECK MENU and select PERFORM CHECK AND CORRECT NOW. This checks and rewrites the boot, partition and FAT sectors of the hard disk and removes any corrupted recording files.</p> <p>Please also check the shock and vibration damping of the X200 as shock and vibration reduce disk life and can also lead to corruptions on the hard disk.</p>

USB Interface Kit

“PC fails to start if USB Interface Kit and cartridge is attached but switched off during start up”

On some PC's Windows may not start correctly if an X200 cartridge is left attached to the PC via the USB Interface Kit during start up. This may be the case even if the cartridge is switched off.

“Hard Disk Cartridge appears to be full When trying to save X200 software from a PC Running Windows 98”

If the hard disk cartridge has V1.51 of the X100 operating system installed on it then although it may have enough free space available to save the X200 .xos file Windows 98 shows the disk as full.

- Connect the cartridge to the PC via the USB Interface Kit.
- Go to My Computer and right click on the Cartridges drive letter.
- Select 'Properties'.
- Select 'Tools'.
- Select error-checking status 'check now'.
- Select type of test as 'Standard'.
- Select 'Start'.
- The scan disk process will detect the following errors: - 'System_b' and 'System' with the option to 'repair the error'
- Select 'OK'
- The scandisk will then detect that the information on the disk can be damaged with the option to repair the error.
- Select 'OK'
- Scandisk will then show the results from scanning the cartridge.
- Select 'Close'

The cartridge will now allow the user to transfer X200 software onto the cartridge.

USB Interface Kit compatibility with Windows XP

Early versions of Windows XP may have some compatibility problems when used with USB2 interfaces such as the USB Interface Kit supplied to connect an X200 Hard Disk Cartridge to a PC. This situation has been resolved with the issue of service pack 1 for Windows XP.

If you are having trouble installing and using the USB Interface Kit with Windows XP then check to see if service pack 1 has been installed (My Computer > View System Information > General Tab). If it is not listed under the System heading, then it may not have been installed and can be downloaded from Microsoft.